

Chip's Challenge Notes

I put together the following notes file while playing Chip's Challenge. The notes for some levels have detailed maps that are very useful, while others levels no descriptions at all (these are the relatively easy ones). This document might be useful to those who are stuck on a particular level. Comments, corrections, and additions are welcomed.

- jaime villacorte (Internet: jaime@tcville.hac.com), 1-May-1990

Level: 1	Code: BDHP	Title: LESSON 1
Level: 2	Code: JXMJ	Title: LESSON 2
Level: 3	Code: ECBQ	Title: LESSON 3
Level: 4	Code: YMCJ	Title: LESSON 4
Level: 5	Code: TQKB	Title: LESSON 5
Level: 6	Code: WNLD	Title: LESSON 6
Level: 7	Code: FXQO	Title: LESSON 7
Level: 8	Code: NHAG	Title: LESSON 8
Level: 9	Code: KCRE	Title: NUTS AND BOLTS

At the end, push the dirt block against the left wall of the room, just above the hallway entrance. Press the button, the clone shoots around the room, hits the block and goes into an infinite loop. Jump into the trap, and after a while, it lets go.

Level: 10	Code: UVWS	Title: BRUSHFIRE
Level: 11	Code: CNPE	Title: TRINITY
Level: 12	Code: WVHI	Title: HUNT
Level: 13	Code: OCKS	Title: SOUTHPOLE

Press down on the joypad and step down away from the question mark.

Level: 14	Code: BTDY	Title: TELEBLOCK
------------------	-------------------	-------------------------

When you push a block into the teleport square, make sure you enter the teleport square in a perpendicular direction from how you pushed the block.

Level: 15	Code: COZQ	Title: ELEMENTARY
------------------	-------------------	--------------------------

At the end, push the dirt block onto the button; at this point, you can safely walk down through the trap.

Level: 16	Code: SKKK	Title: CELLBLOCK
------------------	-------------------	-------------------------

Use the following diagram. Each arrow represents a movement from one "room" to another.

Level 18 Partial Layout

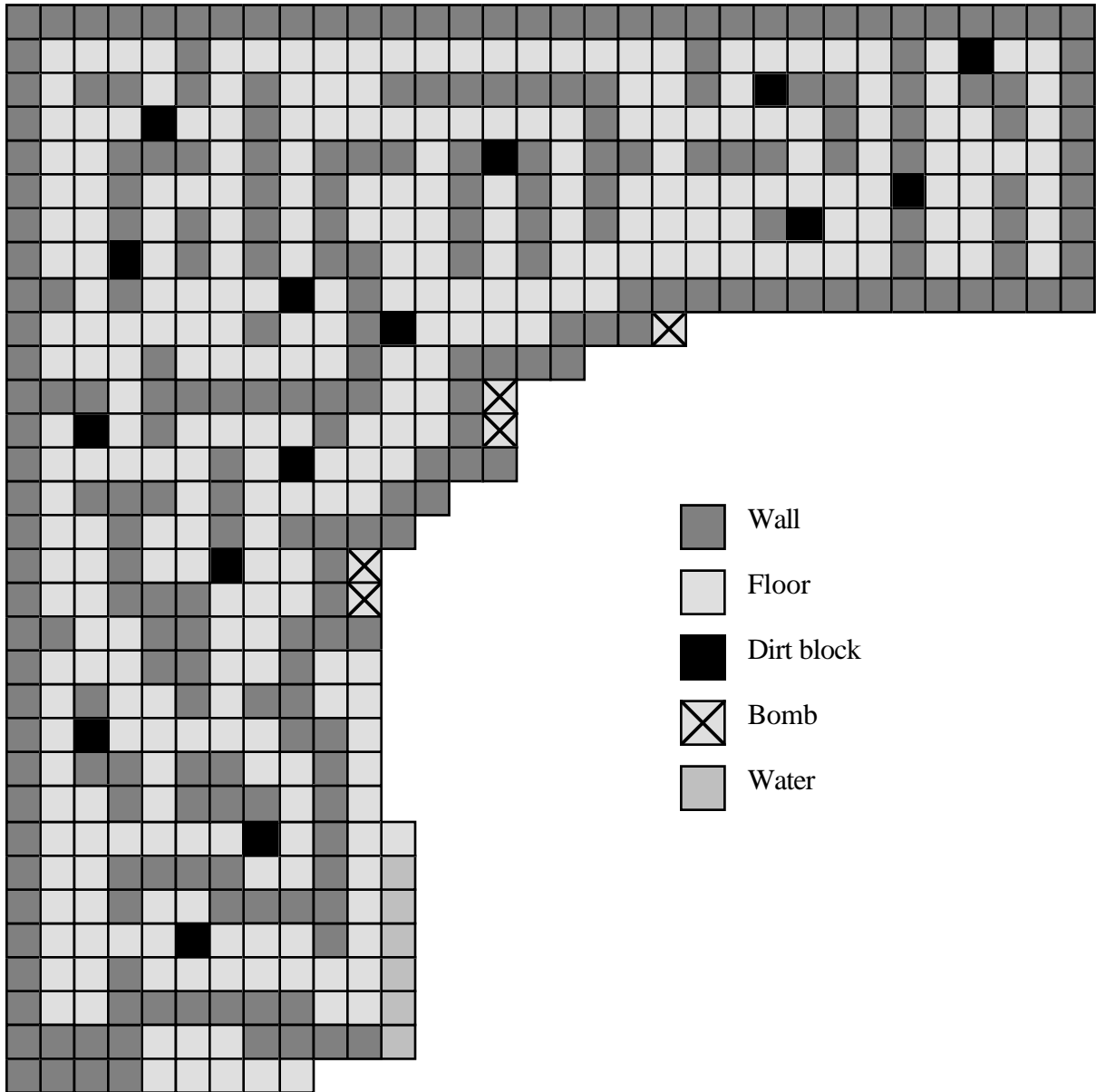

Level: 19	Code: MRHR	Title: DIGGER
Level: 20	Code: KGFP	Title: TOSSED SALAD
Level: 21	Code: UGRW	Title: ICEBERG

Throw dirt blocks into the ice bridge directly above the dirt block generator. Throw in 3 into this bridge, and step onto each one to form stone. This is the path to the exit. Throw dirt blocks 3 cells to the right, and 3 cells up, from the dirt block generator, this forms the path to the chips.

Level: **22** Code: **WZIN** Title: **FORCED ENTRY**
 Level: **23** Code: **HUVE** Title: **BLOBNET**

Perseverance is the key. Take your time getting each chip. Keep a very careful eye on how the green blobs move. I was about to map this level when I realized that there was no point - there is no pattern to move across this level.

Level: **24** Code: **UNIZ** Title: **OORTO GELD**

The only tricky part of this level is to isolate one shark and cause it to hit the trap door repeatedly. In the diagram below, push block 1 in between sharks, then immediately push block 2 to divert the second shark.

Level 23 - Starting action

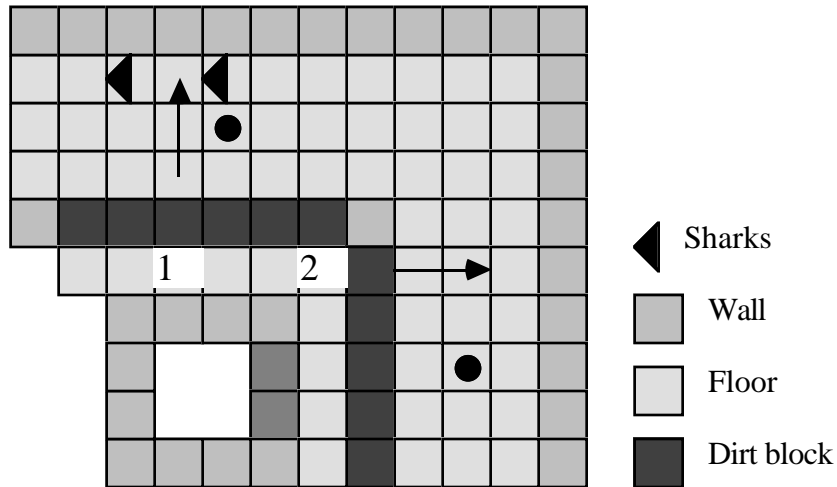

Level: **25** Code: **PQGV** Title: **BLINK**
 Level: **26** Code: **YVYJ** Title: **CHCHCHIPS**
 Level: **27** Code: **IGGZ** Title: **GO WITH THE FLOW**

The blue button triggers the movement of the tank guarding the fire shield. It also triggers whether or not you can get the chips stuck in the left wall next to the fire. The last thing to acquire is the chip in the middle of the water.

Level: **28** Code: **UJDO** Title: **PING PONG**

Yes, you do have to build two bridges out of the four dirt blocks. Entrance is the last cell on the moving staircase.

Level: **29** Code: **QGOL** Title: **ARTIC FLOW**
 Level: **30** Code: **BQZP** Title: **MISH MESH**

The key here is to correctly arrange the dirt blocks (both the three block group and the five block group) so that the monster runs around the circumference of the group and kills itself. The diagram below shows the placement of the first set of blocks. The five block group is similar.

Level 32

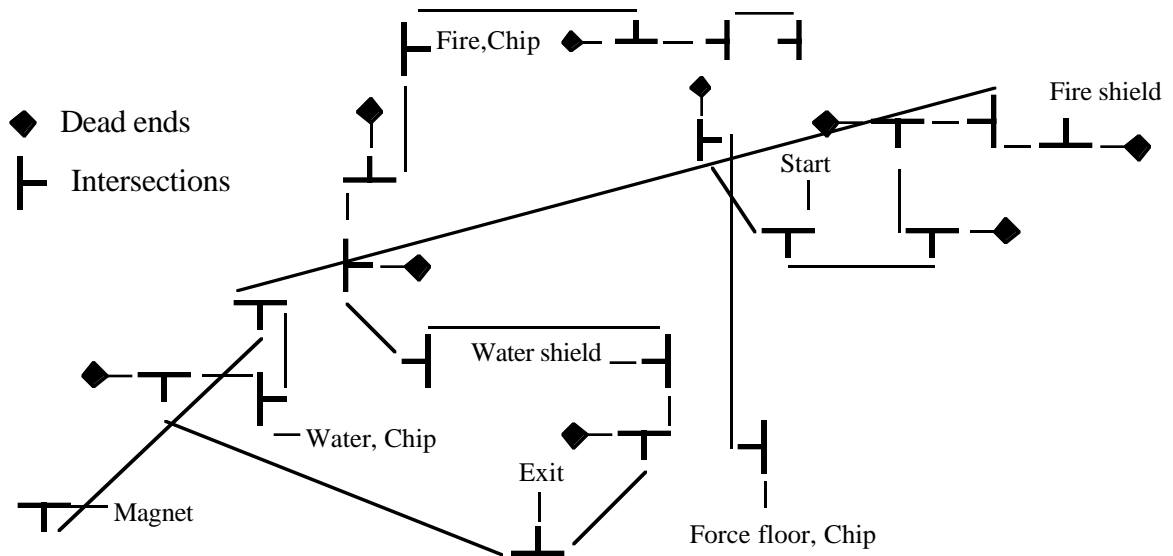

Level: **33** Code: **BQSN** Title: **ON THE ROCKS**

Boo. This was extremely tedious. One mistake could cost you a half hour of your time.

Level: **34** Code: **NQFI** Title: **CYPHER**

Very easy level with a maze of spelling out three 4-letter words: LLIO at the top, HPPX, in the middle and JHEN on the bottom. The 1st is the level 82 code (SOCIALIST ACTION). The 2nd is level 137 (GOLDKEY), and the 3rd is level 146 (CAKE WALK).

Level: **35** Code: **VDTM** Title: **LEMMINGS**

Arrange 3 blocks as shown. This causes many of the monsters to head down into the little room and jump into the water. Many will remain, concentrated mainly to the left. Grab the single chip near the bottom, this causes all the remaining lemmings to go cyclic. Then push a dirt block towards the bottom left chip, leaving a one column space to the chip. With judicious pushing up of this dirt block. You can grab all remaining chips. Careful of the exit - let the remaining lemming exit.

Level 35

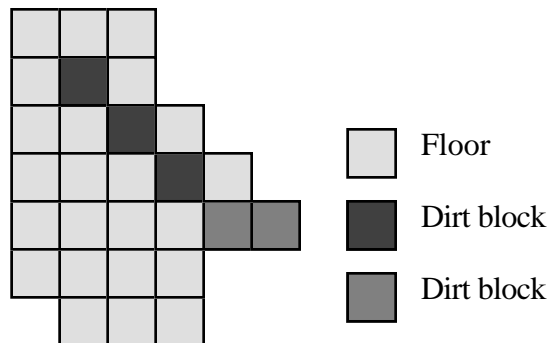

Level: **36** Code: **NXIS** Title: **LADDER**

Relatively easy level. Don't let the trap walls intimidate you. Start to the left and grab the key. Go back right to the starting position and head down. Grab the chips on your left - it doesn't matter which order, I preferred heading down the middle vertically. Proceed to the bottom right of the level, run left along the walls then go up and turn left, grabbing the chips and the blue key. After grabbing all the chips go up a few rows, turn left, find the blue door, open it, trigger all the tanks, grab the chip before the last tank traps it, open the blue door at the top of the level, grab the red key, go back down near the tanks and traverse the fly traps. Use the green button to toggle, and push the dirt blocks to disable corresponding traps. Once the last two chips are obtained, head back out, towards the red door where the exit is. Piece of cake.

Level: **37** Code: **VQNK** Title: **SEEING STARS**

Relatively simple level. No monsters - just an easy test of dirt block pushing. To get to all of the chips at the bottom of the level - you need to grab some dirt blocks from the top.

Level: **38** Code: **BIFA** Title: **SAMPLER**

Neat, simple level with teleporting into several rooms. Follow the sequence numbers below, in order:

<u>Direction</u>	<u>Items</u>	<u>Sequence</u>
Up/Down, Left/Right	Green key, Yellow door, Exit	1,10
Up/Down	Red door, Blue key	5
Up/Down	Chip socket, Red key	4
Up/Down	Water trap, Green button	8
Up/Down	Green door, Magnet	2
Left/Right	Green trap door, Yellow key	9
Left/Right	Blue door, Fire shield	6
Left/Right	Fire trap, Water shield	7
Left/Right	Force Floor, Chip	3

Level: **39** Code: **ICXY** Title: **GLUT**

Simple minded level full of chips. Just go down and take a right, once past the mouth monsters. It's hard not to get this in the first try. This level should be rechecked for any easter eggs. There might be something under all those chips.

Level: **40** Code: **YWFH** Title: **FLOORGASBORG**

Another easy level - From the start, step 2 up and step on the force floor to the left. Force a right turn immediately. Follow the path, but when you're near the middle at the top, force down, land on the thief, get the fire shield. Step to the left and up,

forcing yourself up. Let the force floor guide you until you get the water shield. Walk on water, grab the magnet, walk on water to the left and up, grab the ice shoes. Walk to the exit.

Level: **41** Code: **GKWD** Title: **I.C. YOU**

Relatively easy level . First grab the 16 chips around the circumference of the bugs paths. Wait until there's a gap and immediate follow the bugs. Remember to go in the wall-hugging direction. Pause in the middle after getting the first eight. Grab the next eight similarly. Teleport, read the clue)Teleport direction sequence: 1st RDUL, 2nd LULU), and follow the directions it gives (RDUL=Right, down, up, left) after each teleportation, grab the chips accessible.

Level: **42** Code: **LMFU** Title: **BEWARE OF BUG**

Take this warning literally. You can do the following, or maybe just wait sooner until the last bug passes. T = Top, B = Bottom, L = Left, R = Right, n = nth from the outside.

TL1: Step away. Let bug pass. Run down.
BL1: Stay put. Let bug pass. Run right. Grab BR1. Run Up. Grab TR2.
TR2: Stay put. Let bug pass. Run left. Grab TL2.
TL2: Stay put. Let bug pass. Run down. Grab BL2.
BL2: Step away. Let bug pass. Grab remaining chips and exit.

Level: **43** Code: **UJDP** Title: **LOCK BLOCK**

Relatively simple level. Grab the key on the right side first. Hardest part is running past the blue ball using the force floor. Wait until the ball just started its rightward movement then jump on.

Level: **44** Code: **TXHL** Title: **REFRACTION**

Interesting level. Watch out for the bouncing ball. Each quadrant of this level has 8 chips. I went in the following order: BL, TL, TR, BR, and ended with 9 seconds to spare.

Level: **45** Code: **OVPZ** Title: **MONSTER LAB**

Look for any islands that generate dirt blocks, and use the blocks to stop any moving monster train. This will cause the monsters near the exit to be blocked off from cloning, and will allow you to walk to the exit (from the left).

Level: **46** Code: **HDQJ** Title: **THREE DOORS**

Seemed pretty straight forward. Grab red key. Open red door. Go down and pick up fire shield and green key. Step up. Go to the left and grab water shield, blue key and chip. step left, go up and grab red key. step right, go up and grab 3 chips and yellow key. return to start and head down force field tracks. Open blue door, get blue key, chip and magnet. Go up, through yellow door, collect chips, grab yellow key, head for start. Go through doors, through teleport, and choose far left aisle to go up. Should recheck this for easter eggs - there's a large area full of monsters that I didn't have to enter.

Level: **47** Code: **LXPP** Title: **PIER SEVEN**

Simple level, once you know where to put the seven blocks to form a bridge to the island where the chips are:

Level 47

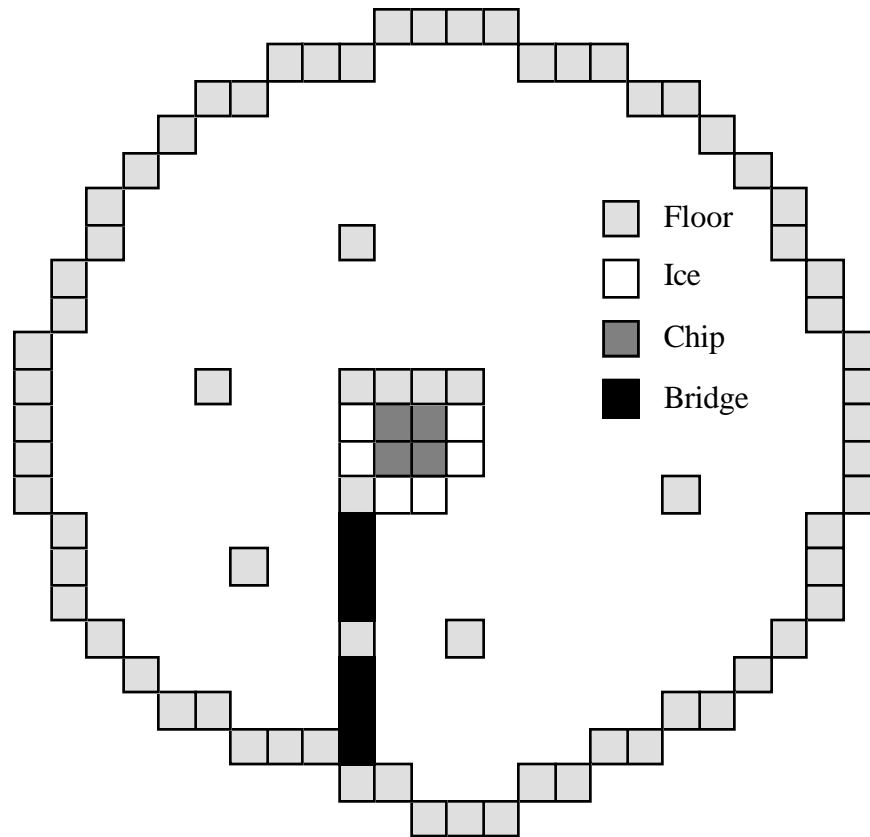

Level: **48** Code: **JYSF** Title: **MUGGER SQUARE**

Grab chip in starting room, don't get the ice shoes now. Bear down and left. Go through thief, get ice spikes, Go into the teleport from the bottom (push joypad down). Go through ice. Do NOT grab water shield. Grab chip. Go up, through middle mugger, picking up a water shield and enter teleport from the left (push joypad to the left). Walk through water and pick up both chips. Go right, step through middle mugger, get fire shield, go through teleport from the top (push joypad up). Go through fire room, grab chip, magnet. Go down, avoid muggers, and grab last chip. Go right, into starting room and get ice spikes. Go into the teleport from bottom to top. Go through ice and grab water shield. Go up through exit on top, avoiding muggers. Enter teleport from the left, Go through water and exit is on the right.

Level: **49** Code: **PPXI** Title: **PROBLEMS**

Grab the keys in a counter clockwise direction to maximize the time. Open all doors, and grab all the chips in the room below. Use chips closer to the left of the room to shield yourself. I started from the left bottom and worked my way up. Exit is on the top left.

Level: **50** Code: **QBDH** Title: **DIGDIRT**

Think figure-8s in this level. Make a tunnel adjacent to each insect room, using each insect as the top or side of a figure eight, and you make a tunnel completing the figure 8.

Once past this level you get the message "PICKING UP CHIPS IS WHAT THE CHALLENGE IS ALL ABOUT. BUT ON THE ICE, CHIP GETS CHAPPED AND FEELS LIKE A CHUMP INSTEAD OF A CHAMP."

Level: **51** Code: **IGGJ** Title: **I SLIDE**

Simple ice-only level.

LEVEL 51

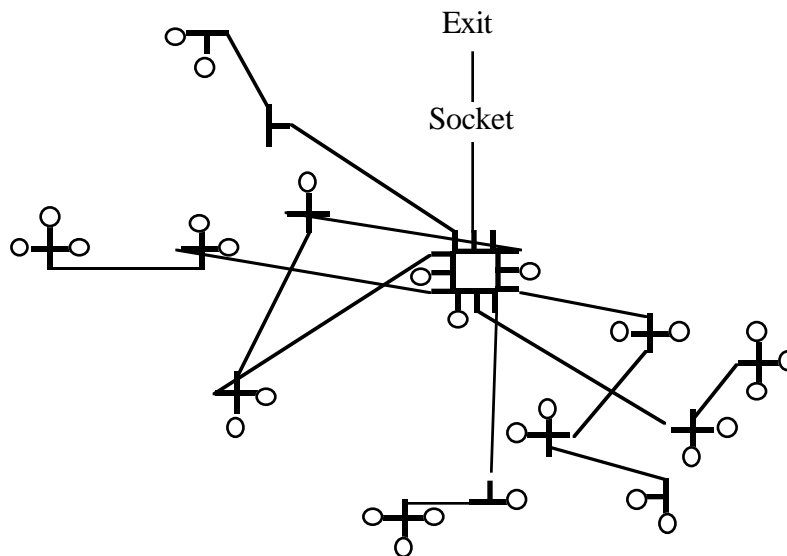

Level: **52** Code: **PPHT** Title: **THE LAST LAUGH**

Use the parallel force floors on the bottom to make the mouth monster step on the green button from the right and then step back to the left. Grab the chip on the left. Go back down and psyche out the mouth monster to enter the room on the right. Grab the chip (go from left/bottom to top/right) and move towards the middle of the upper level enough so that the mouth monster presses the green button once. Then it's a cake walk back to the exit.

Level: **53** Code: **CGNX** Title: **TRAFFIC COP**

The following hint is given for this level: "MAKE THOSE PESKY MONSTERS FOLLOW A PATH TO THE DOOR TRIGGER."

Do exactly what this hints says - use the dirt blocks to make walls to bounce the monsters around. I used two block per turn to prevent the monsters from going in an unintended direction.

Level: **54** Code: **ZMGC** Title: **GRAIL**

Use the dirt block generator to create blocks to help make a pathway to the water shield and the yellow key. Grab the fire shield. Collect the chips, and get into the yellow door where the exit is - I don't know what the other keys were for (green and red).

Level: **55** Code: **SJES** Title: **POTPOURRI**

Push the block into the cherry bomb, grab the chip. With some quick joypad work, grab the blue key and the fire shield. Go to the bottom left of the level through the fire shield (avoid the mugger under the dirt block), grab all the chips,. Go through the door, grab chips in the ice. Go up and to the left, collect chips,. Last chip is embedded in the dirt. The one in the middle of the level appears to be a red-herring.

Level: **56** Code: **FCJE** Title: **DEEFPREEZE**

Once all the chips are collected. Enter top left ice rink thorough middle right.

Level: **57** Code: **UBXU** Title: **STRANGE MAZE**

A very simple maze, that just tests you joypad control power- just make sure all chips are collected from a region, so you don't have to spend the last few seconds scrambling around looking for it.

Level: **58** Code: **YBLT** Title: **LOOPING AROUND**

Interesting "exploring" type level - lots of hidden walls, especially on the sides of the force floor. Grab the water shield first, avoid the mugger (how can you not ?!) and grab the chips, being careful of the blue balls.

Level: **59** Code: **BLDM** Title: **HIDDEN DANGER**

Down the ice path. Press green button. Grab red key. Proceed left. Grab 4 chips and magnet, water and fire shields. Get last chip. Press green button. Wait until ice sharks are trapped then slide up the ice path and enter the exit from the bottom up. I think the red key and red door is a red herring.

Level: **60** Code: **ZYVI** Title: **SCOUNDREL**

There are 3 blocks in the right side of the corridor, 4 in the left side, 3 down in a room locked by yellow and blue doors, and 2 accessible in the small fire and bug protected room at the bottom left. The hard one to find is in the 4th chip in the left, accessible only by using the force floor and jumping to the right into a hidden hallway.

Level: **61** Code: **RMOW** Title: **RINK**

Just before this level the following message appears: " CHIP HITS THE ICE AND DECIDES TO CHILL OUT. THEN HE RUNS INTO A FAKE WALL TURNS THE MAZE INTO A THRASH-A-THON. "

The following map might come in handy...

Level 61

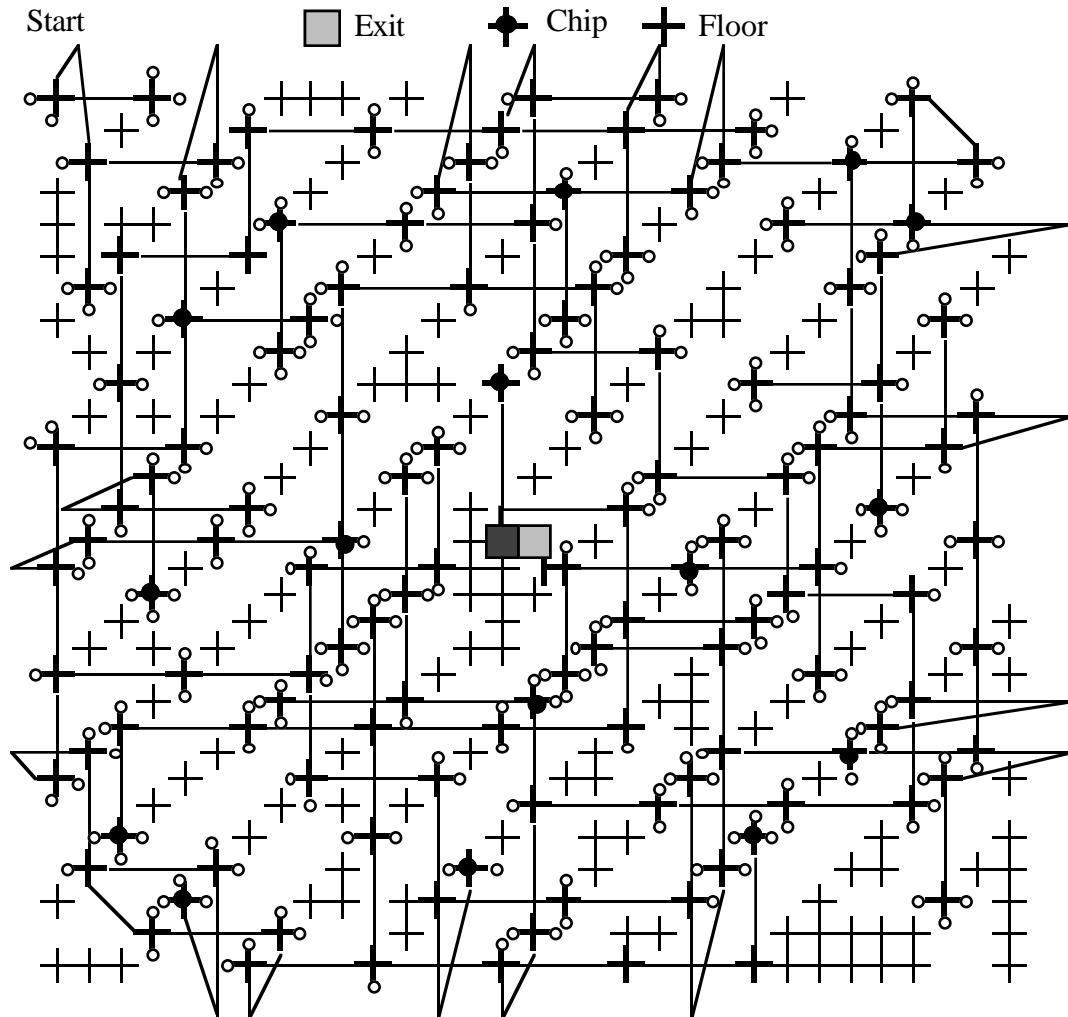

Level: **62** Code: **TIGW** Title: **SLO MO**

I waited until the monsters were very close to me. Then I used the small clear segments to get run away from them. Exit is on the far right side of the level.

Level: **63** Code: **GOHX** Title: **FACTORY**

Start the factory by pressing the top button once. From here on, make sure you use the bottom-most block first - don't use a block if there is another block beneath it - otherwise, life gets tough with dirt blocks sliding back and forth on the ice. The last chip is on the bottom left of the level. Use the force floors to get there. Trip the red button to start the solitary block sliding back and forth, grab the chip, and move back up pushing the dirt block covering the button. Then proceed down the left-most column to the exit.

Level: **64** Code: **IJPQ** Title: **SPOOKS**

Interesting variation of tread-lightly scenario - this is relatively simple. Just follow the adage, "if you can put a path into the dirt block without getting eaten, then there's probably a chip there". Good joystick control is a must.

Level: **65** Code: **UPUN** Title: **AMSTERDAM**

Relatively simple level. Just make sure, before pushing a dirt block into a cell to grab a chip, that there is room for you to maneuver. Also make sure to grab other chips in adjacent cells.

Level: **66** Code: **ZIKZ** Title: **VICTIM**

Ridiculously simple level if you do the right thing. Run down into the teleport and immediate run back up. Make sure not to push the dirt block on the top green button. Collect the 12 chips around you, making sure not to grab the 2 chips on either side protecting you from the monsters. Then go up the corridor, and head towards the socket on the right and beyond that is the exit.

Level: **67** Code: **GGJA** Title: **CHIPMINE**

An annoying but simplistic level in which all the chips are embedded in a sea of blue blocks which turn into walls/paths when you touch it.

Level: **68** Code: **RTDI** Title: **EENY MINY MOE**

Grab the chips in the spiral. Use the dirt block in combination with a chip to block the escaping monster until its eventually back where it came from. Then proceed to room with the sharks, Use the dirt blocks in combination with the traps to guard 2 adjacent chips from direct horizontal or vertical attack by the monsters. Use 2 of the dirt blocks to guard against the sharks coming back through the entrance. Once the dirt block is engaged, wait until steady state and grab the chips. The last twelve chips are retrieved using bridge using 5 of the useable dirt blocks from the right room in combination with the ones in the long room.

Level: **69** Code: **NLLY** Title: **BOUNCE CITY**

Make sure you have a red, yellow, blue keys for opening to doors to the exit. Choose the yellow door to the right.

Level: **70** Code: **GCCG** Title: **NIGHTMARE**

Tough level - many tricks, plus timing. Key things: trap land shark with green button. Trap first pink monster in the left aisle with dirt block and step aside for the second monster. Press blue button near tank twice in a row to pass the tank. The last two dirt blocks in the ice can be pushed to the left to make a path for going into the red door. Grab the red key, and avoid fire bugs, and exit to the right, using force floor.

After finishing, the message which appears is: " CHIP IS HALFWAY THROUGH THE WORLD'S HARDEST PUZZLE. IF HE SUCCEEDS, MAYBE THE KIDS WILL STOP CALLING HIM COMPUTER BREATH. "

Level: **71** Code: **LAJM** Title: **CORRIDOR**

Only difficult part is figuring out the correct pushing sequence to grab the chips in the room full of dirt blocks.

Level: **72** Code: **EKFT** Title: **ALLEY**

Very easy level - just listen to the "beat" of the moving tanks.

Level: **73** Code: **QCCR** Title: **MORTON**

Interesting maze level. Map is below - only trick is to draw the monster into a corner where you can double back on it. I used the lower left corner, with a parallel dog leg which dead-ends to trap the monster.

Level 73

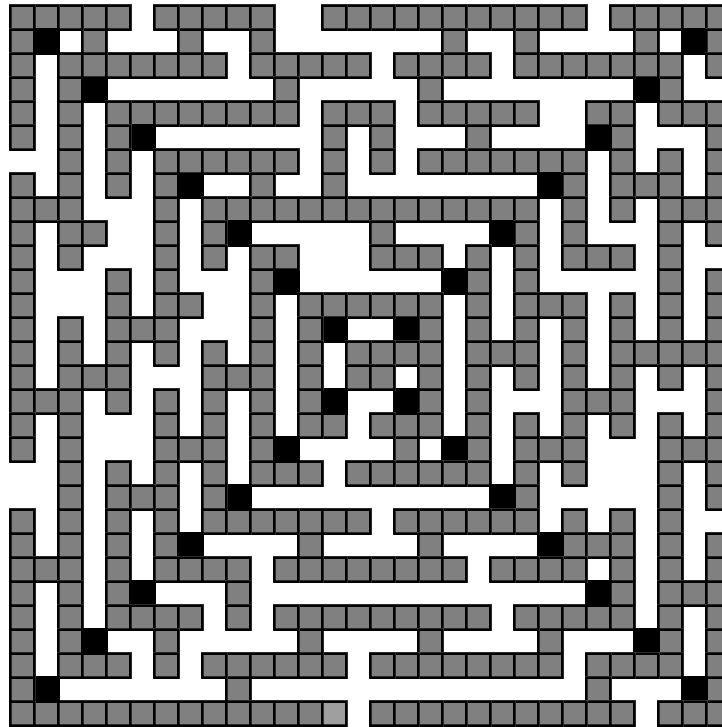

Level: **74** Code: **MKNH** Title: **PLAYTIME**

Relatively simple level. Only interesting trick involves having to grabbing the chip in the middle of the force floors. Follow the bouncing ball until near the end, then jump on to the force floor traveling left to right. This goes straight to the chip without meeting any monsters. The rest of the chips are accessed by a "wait and do it" method.

Level: **75** Code: **MJDV** Title: **STEAM**

Fun level...You need a water and fire shield to get to the exit:

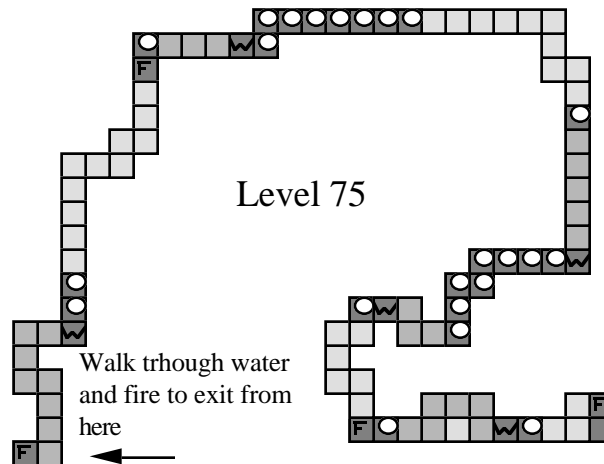

Level: **76** Code: **NMRH** Title: **FOUR PLEX**

Four part coordination level. lower left quadrant is easy - start by sliding to the left. You'll end up pushing through a fake blue block in order to get the red key. Exit is from the left of the force floor. The next part involves grabbing the chips on the parallel force floors - make sure to grab the chip on the lowest level first. The upper right quadrant has no real tricks - just be careful in not stepping in the traps, or launching a monster without a target. The last part involves grabbing chips in changing stone floors. You'll need a water shield to get across to the exit.

Level: **77** Code: **FHIC** Title: **INVICIBLE CHAMPION**

Make a dirt path that leads from the inner chamber to the water on the lower right. Either use the shark that's already moving or launch one to push the bugs out of the way. Relatively easy level.

Level: **78** Code: **GRMO** Title: **FORCE**

Another easy level. No tricks here - just careful planning of routes across force floors. There's an opening on the left side of the initial starting room.

Level: **79** Code: **JINU** Title: **DRAWN AND QUARTERED**

In the initial starting room, grab chips and approach the teleporter from the bottom. Approach the chips in the next room from the top left, not making a direct path on the bottom to the teleporter. Double back to the teleporter, and on the third up/down teleport, grab the chips. Advance to the last level, and careful stepping is all that's required. An easy level.

Level: **80** Code: **EVUG** Title: **VANISHING ACT**

Tough level. The following map might come in handy.

At the end of this level, the following appears on the screen: " CHIP USED TO SPEND HIS TIME PROGRAMMING COMPUTER GAMES AND MAKING MODELS. BUT THAT WAS JUST PRACTICE FOR THIS BRAIN-BUSTER! "

Level 80

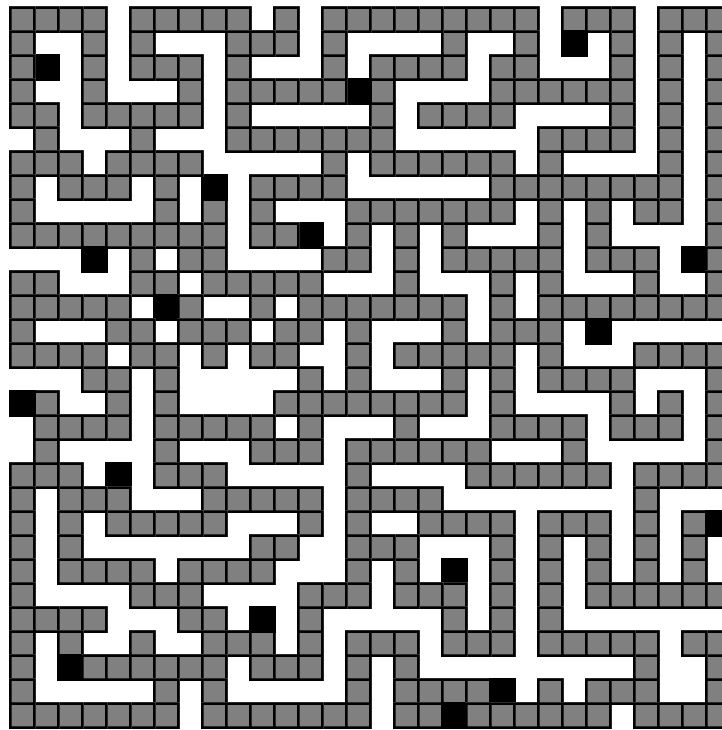

Level: **81** Code: **SCWF** Title: **WRITERS BLOCK**

There's 2 blocks at the start, and for each letter of THINK, there's 11, 16, 7, 19, and 14 respectively. This makes a total of 69 blocks, but there are 2 sets of four blocks which cannot be used, and also one block of the top part of the "T" which must be sacrificed to get the other blocks. That leaves 60 blocks to use. There are 56 chips, with one block per chip, except the chips at each of the 4 corners needs an extra block to extract. I started with the K, then went around and used the T, H, and I. The N must be worked from both directions. I entered the bottom left of the N, just one row above the bottom. The same technique can be used at the top right of the N.

Level: **82** Code: **LLIO** Title: **SOCIALIST ACTION**

You need to get to the top left of this level, marching with the bugs around the invisible/reappearing walls. I went straight up at the top and joined them there. Once down the left side, lead the 2 mouth monsters and the 1 bug into the lake. The exit is on the middle right.

Level: **83** Code: **OVPJ** Title: **UP THE BLOCK**

You'll need to extract the dirt block into the middle room where the sharks are. Use the force floor to push the block from behind. Be sure to push it down the right vertical hallway, and not the left one, otherwise you're trapped. With careful maneuvering of this block, the sharks are guided straight down into the red bombs. Grab the chips in the left room and then use the dirt block to pop the remaining balloon to get access to the right room. Grab the unguarded chips, and pop the 6 bombs in the guarded rooms with similar maneuvering of another dirt block.

Level: **84** Code: **UVEO** Title: **WARS**

Push the dirt block against the left ball, and position it to guide the balls to the right to impact against the bugs. Wait near the bottom middle of the bugs trail and work up, moving counter clockwise and grab 4 chips. Push the dirt block down a couple, until the balls are guided into the other horizontal hallway, wait until its clear, grab the last chip and exit.

Level: **85** Code: **LEBX** Title: **TELENET**

Get the blue key on the far left, work your way to the right and open the blue door, grab the chip. The remaining chips, the red key, and the red door are traversed in order through teleports. Use the following sequence of directions of movement into a teleport, in order to land in a safe square to the next room: R, U, U, R, U, R, L, U, R, L, U, R, D, U, L, D. Once grabbing the red key, follow the sequence again to return back to the red door.

Level: **86** Code: **FLHH** Title: **SUICIDE**

Interesting level, where all the work is done by bouncing sharks. Position the dirt block, just above the blue button (do it in two passes). Wait in the left most nook that's protected by an overhanging wall to the left of the balloons. With around 309 left on the clock, the last balloon is burst and the exit is free to enter.

Level: **87** Code: **YJYS** Title: **CITYBLOCK**

A very tedious and unforgiving level. Build a bridge along the top and left side of the lake. Build a parallel bridge along the top to aid building of a bridge along the left side. Build a bridges along the right wall to access the chips at the bottom. Push dirt block down the ice. Then push it all the way down the hallway. You'll need to push the first block on the right, into the pathway. Push the first left block into the ice path, dodging downwards to avoid getting hit. Push this block along, and work your way clockwise to get the chips. Head towards the socket and work your way along the top and the right sides of this room, carefully pushing blocks out of the way to get to the exit. It's extremely important to think through the block pushing, especially at this stage when you've invested so much time.

Level: **88** Code: **WZYV** Title: **SPIRALS**

Simple spiral maze level, where you're being chased by X monsters. You need to quickly grab the four chips at the top and work your way back down to the exit on the right.

Level 88

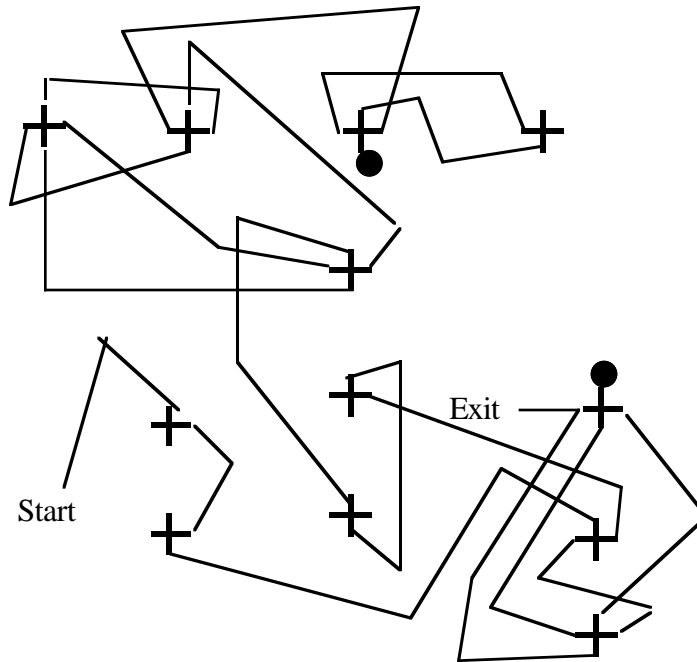

Level: **89** Code: **VCZO** Title: **BLOCK BUSTER**

Simple level. Start with the upper right button and create bridge to grab red key. Work your way down and to the left the build a bridge that snakes to the green key stuck in the wall. The toughest part will be getting through the second sliding block obstacle. For this, just move up as soon as the dirt block touches the right wall.

Level: **90** Code: **OLLM** Title: **PLAY HOUSE**

Start with grabbing the yellow key on the left through the invisible blue blocks. Use a 2 block wide bridge to go up across the water in the middle of the level to grab the blue key. Proceed to the bottom of the level, bear right and grab the chips against the right wall. Go back to the left, open the blue door, slide to the middle right room and grab the chips and green key. Then work your way back to the start, opening the green door in the left hallway. I used the force floor to get by the blue balls. From here it's a piece of cake. Remaining chips are across blue ball/fire wall combination.

The following appears at the end of this level: " 'I CAN DO IT! I KNOW I CAN!' CHIP THINKS AS THE GOING GETS TOUGHER. BESIDES, MELINDA THE MENTAL MARVEL WAITS AT THE END! "

Level: **91** Code: **JPQG** Title: **JUMPING SWARM**

Simple level - just grab chips and avoid a pack of x monsters. Exit is on lower right.

Level: **92** Code: **DTMI** Title: **VORTEX**

Difficult level. Follow the maze and grab the chip in the upper left hand part of the maze. Enter the teleport work your way around the spiral and grab the green key work your way to the upper right part of the level, grab the blue key and work your

way back to the upper left teleport. Work your way through the vortex, grabbing the last chip, opening the blue door and exiting.

Level: **93** Code: **REKF** Title: **ROADSIGN**

Interesting level tests your block moving ability. There are a total of 3 dirt blocks that are in the level that must be moved to create a bridge across the two water bodies, and the last water guarding one chip.

Level: **94** Code: **EWCS** Title: **NOW YOU SEE IT**

Relatively simple level - find 7 chips embedded in a maze with invisible/appearing walls, with no time limit.

Level: **95** Code: **BIFQ** Title: **FOUR CORNERS**

From the starting position, go straight down, teleport, and push the bottom dirt block down. Grab the red keys and push the 3 remaining dirt blocks into their respective water holes in the other screen. You'll end up grabbing the yellow key and the blue key. Use the yellow key to open the yellow door of the starting screen, and also grabbing a chip. Use the blue key and teleport back to the second screen and open the blue door at the right to grab a second chip. Hurry on back to the starting screen and exit.

Level: **96** Code: **WVHY** Title: **PARANOIA**

The blue question marks says, " YOU DON'T NEED THE HEAT SHIELD, BUT IT COULD HELP LATER ON. "

This is a relatively simple level. Tips: When grabbing the chips guarded by the horizontal bouncing blue balls, stay embedded in the walls until it's clear. When picking up the last set of chips guarded by fire bugs, run around the circumference of the room to avoid invisible walls.

Level: **97** Code: **IOCS** Title: **METASTABLE TO CHAOS**

Dig a tunnel that traverses this level counter-clockwise and form a loop; then use the two dirt block and position it near the entrance of the bug-infested hall. Once the second dirt block is positioned, bugs will start marching out, and when enough have left, slowly work your way to the exit.

Level 97

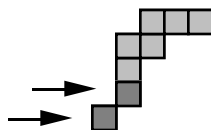

Level: **98** Code: **TKWD** Title: **SHRINKING**

For the upper left and middle left rink, use dirt a pair of obstacles made of two dirt blocks, placed on the force floor. The other chips can be obtained by quick-footed work to get across the streams of blue-balls. The dirt blocks must also be used in the exit.

Level: **99** Code: **XUVU** Title: **CATACOMBS**

Strange but easy level. Remember that pressing a brown button disables a trap (i.e. any monster currently trapped is free to move). This is probably the key concept to this level. From the starting position, go straight up until you hit the top wall. Push the

dirt block down two grids where a water shield is revealed. Don't grab the chip on your right, but instead work your way down, press the brown button to get by the blue tank. Open the blue door, but only step on the top red button. Grab the middle yellow key only. Proceed to the left and starting with the yellow door at the top, start grabbing keys and chips, being careful to grab keys before grabbing the corresponding chips (otherwise, blue tanks land on brown buttons which releases the blue balls. 7 of the 8 chips can be gathered here without going back to the one chip originally ignored in the beginning.

Level: **100** Code: **QJXR** Title: **COLONY**

Whew. Tedious, joypad-control intensive level. Exit is on the bottom left of the level. Short controlled movements (form middle of cell to exit and from exit to middle of cell) is probably the key here.

At the end of this level, the following screen appears: " BESIDES BEING AN ANGEL ON EARTH, MELINDA IS THE TOP SCORER IN THE CHALLENGE--AND THE PRESIDENT OF THE BIT BUSTERS. "

Level: **101** Code: **RPIR** Title: **APARTMENT**

Interesting level. Here's the path I used in collecting the chips. Perhaps there are other ways:

Level 101

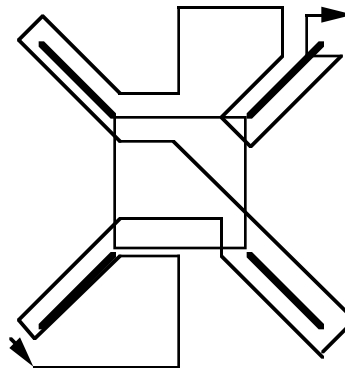

Level: **102** Code: **VDDU** Title: **ICEHOUSE**

From the start, push the joypad left - otherwise when you finally get near the red button, you get hit right away. Once you do land on the button step to the left immediately, grab the 2 chips, shield and red key, and work your way down and to the right. Open the red door, grab the water shield and yellow key and head down, bouncing off the ice. Walk to the left, step across the ice and walk across the water/fire barriers. Enter the bottom horizontal corridor guarded by a burglar and yellow door. You'll need the spiked shoes to walk against the force floor to the exit.

Level: **103** Code: **PTAC** Title: **MEMORY**

This is a good name for this level. You just need to explore all combinations of pressing of blue/green buttons to grab all the chips.

Level: **104** Code: **KWNL** Title: **JAILER**

Grab all four keys at the start and basically take your time going through all the corridors. The middle corridor at the bottom only guards the 2 exits, but the left exit can be accessed when you are done grabbing all the chips in the bottom left room. There are 4 rooms in each corner of the level with chips. The other 3 green doors lead to corridors with 2 chips each. Corridors guarded by a chip don't contain any more chips.

Level: **105** Code: **YNEG** Title: **SHORT CIRCUIT**

Another of those levels full of step-over-and-it-becomes-a-wall blocks. The hard part about this is figuring out the correct path to traverse in order to grab all the chips. I think this is almost impossible without a map, and even with the map, it takes a little thought to figure out the correct path to traverse. I don't know if the path shown below is the only solution, but it does involve performing "cutbacks" across unstepped-on walls, and old chip locations - pretty tricky.

Level 105

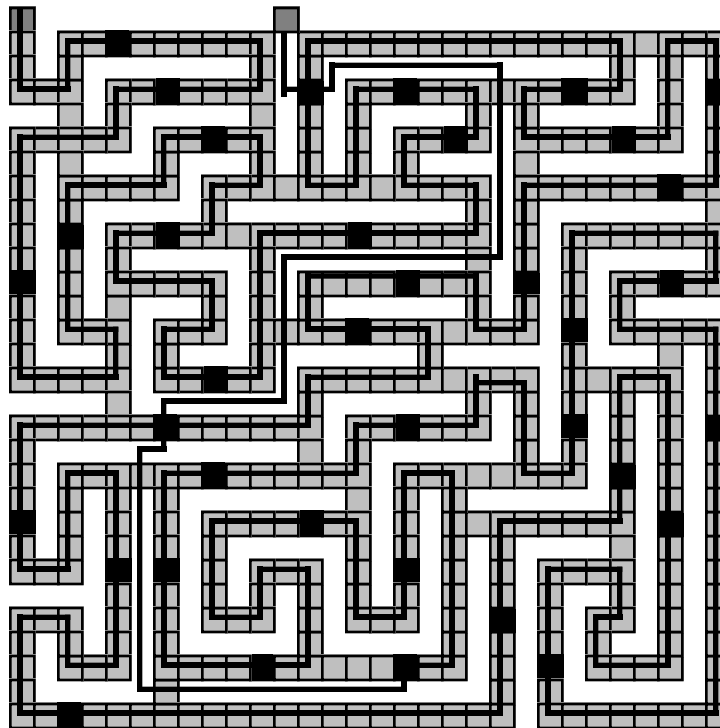

Level: **106** Code: **NXYB** Title: **KABLAM**

Interesting level full of bombs. A clone machine generates fire balls that you guide around with dirt blocks. There's no time restriction. The exit is on the bottom left of this level. This is the direction of travel for the fire balls: up, right, down, left (this is across the bridge of water), up, right, then down. Neat.

Level: **107** Code: **ECRE** Title: **BALLS O FIRE**

Another neat level. Exit to the right, grab the chip and push the dirt block down. I headed for the left and grabbed the chips there and worked my way back to the middle, grabbed the fire shield and then grabbed the chips on the left. Use the dirt

block that you initially pushed away, and push it into the middle right chamber, then down past the water. Grab the chips which spell out the word "CHIP" and grab the keys in both left and right corner. Use one of the two blocks to fill in the remaining water block, and then use the other block and line it up along the right side of the exit. I used the blue key to open the blue door on the right, but I suppose you can do the same thing on the left. Use the remaining dirt block and push it up and use it to cross the single water hazard. The exit is near the middle.

Level: **108** Code: **LIOC** Title: **BLOCK OUT**

Nothing complex here. It's obvious you have to use a dirt block to gain entrance to the first blue door. Simple jam the block against the wall and push up until it's above the door. Later on, you'll use another dirt block to prevent blue balls from entering hallways where the chips are. The rest is just tip-toeing across more blue balls.

Level: **109** Code: **KZQR** Title: **TORTURE CHAMBER**

A short level that requires adept joystick control. You'll need to run with the sharks around the force floor to grab the first chip, then head on back and do a slalom run on the force floor to get the second chip. Push the dirt block on the force floors, and keep following, but don't push all the way. The hardest part is grabbing the last chip. To get the chip, you need to go down one block, the left across the ice, then down again. Keep the joystick pressed left as you go across the ice. To get to the exit. Go straight down until you hit the wall and take a quick left.

Level: **110** Code: **XBAO** Title: **CHILLER**

I started with the chips on the bottom of this level. You'll need to use all dirt blocks except one, and this will involve pushing down from the top of the room (accessed by moving up along the corridor where the blue balls are bouncing vertically). The bottom level is relatively simple in concept, but the blue door requires a little timing. The rest of the chips are accessed by pushing 5 dirt blocks along each of the 5 squares adjacent to the ice.

At the end of this level, the following screen appears: " CHIP CAN'T WAIT TO JOIN THE BIT BUSTERS! THE CLUB'S ALREADY FIGURED OUT THE SCHOOL'S PASSWORD AND ACCESSED EVERYONE'S! "

Level: **111** Code: **KRQJ** Title: **TIME LAPSE**

Strange level. I just started pushing the dirt blocks down vertically to bust the bombs and grabbed the fire shield. A pair of chips are in both bottom corners, and the exit is in the middle. I suppose this level could have been harder, with the idea of you being encased permanently in the green trap/door walls.

Level: **112** Code: **NJLA** Title: **FORTUNE FAVORS THE**

There's a dirt block above the starting position. Push it all the way to the left, past the bugs and against the wall. This force the bugs away from the corridor leading to the exit. Once positioned, go back and grab the chips (the 1st of 4 chips is under the dirt block at the entrance). If you're lucky, there won't be that many bugs wandering the corridor next to the exit.

Level: **113** Code: **PTAS** Title: **OPEN QUESTION**

The blue question mark says: "THE EIGHT BLOCK IS OPEN".

Sure enough, the eight blue block from the left is the open one. You'll need 3 blocks on the 7th column to divert the monsters, 2 blocks to make a bridge up the eight column and 1 more block to push into the pathway of the first blue ball you

encounter. The rest of the level is judicious, and quick stepping across a field of other blue balls.

Level: **114** Code: **JWNL** Title: **DECEPTION**

No real tricks here. Relatively simple level that requires dodging from bugs/fire balls in the beginning.

Level: **115** Code: **EGRW** Title: **OVERSEA DELIVERY**

Interesting level. From the starting position you'll come to island 1. You'll teleport 15 times before you reach the final island. All four blocks must eventually be brought to this last island, creating a bridge to the exit, parallel to the bottom edge of the island. The following are directions to approach each teleport, starting with the 1st. After pushing a block into a teleport, always enter the teleport from a different position. This is the rule except for the last (15th) teleport, in which you must enter the teleport in the same direction as you pushed the block (that's DOWN), in order to facilitate creation of the bridge to the exit. Here's the directions: (1) UP, (2) RIGHT, (3) DOWN, (4) LEFT, (5) RIGHT, (6) DOWN, (7) UP, (8) DOWN, (9) RIGHT, (10) UP, (11) DOWN, (12) UP, (13) LEFT, (14) RIGHT, (15) DOWN.

Level: **116** Code: **HXMF** Title: **BLOCK BUSTER II**

Similar to the BLOCK BUSTER level, except the puzzle that appears on the top is slightly harder. I ended up using the lower right button to create a block that I could push down, into the hallway from the top. This extra block is used to grab the blue key. The lower level is similar to the original BLOCK BUSTER.

Level: **117** Code: **FPZT** Title: **THE MARSH**

Relatively simple level. The path meanders first to the right, then a little down, then heads towards the left wall. From here it goes down slightly and you'll end up creating a bridge that spans left to right. Be careful on how blocks are pushed out of the way. Many of them are used to create a bridge around the fire trap and to the last dirt block.

Level: **118** Code: **OSCW** Title: **MISS DIRECTION**

Follow the ice down, grab the green key (entrance is from the bug side). Avoid the mouth monster, head back down, open the green door, grab the blue key and come back to the starting position. Open the blue door, grab the red key. Work your way around to the red door, open it, go across the water, into the teleport. Exit is after the 2nd teleport.

Level: **119** Code: **PHTY** Title: **SLIDE STEP**

Relatively simple level. Make sure to grab the fire shield at the upper right of start before grabbing the chips.

Level: **120** Code: **FLXP** Title: **ALPHABET SOUP**

The following describe the direction of escape from each "letter" room. A: UP - grab blue key; enter from invisible right wall. B: DOWN - (mouth monster room). C: RIGHT - Push block against bottom wall. D: LEFT - Don't grab the chips when first encountering this room. E: RIGHT - Grab 1 chip; get green key. F: LEFT - Grab 4 chips; be sure to press brown button odd # of times; fire shield is under dirt block; push dirt block up to reveal. G: RIGHT - Grab 3 chips, ice shoes. H: UP - Press buttons; explode bombs. Cycle through A, B. C: LEFT - grab yellow key. D: LEFT - Far right dirt block is booby-trapped. Go into upper solid wall/floor, turn right, grab chip, down to invisible walls, leads to chips. E - Green key under dirt block. Always exit E going to the RIGHT. Go through F then G. H has water shield in fire trap. Go green then yellow doors, then thru exit.

At the end of this level, the following appears: "IF CHIP'S GRADES AREN'T AS GOOD AS MELINDA'S, MAYBE SHE'LL COME OVER HIS HOUSE AND HELP HIM STUDY!"

Level: **121** Code: **BPYS** Title: **PERFECT MATCH**

Use dirt block to eliminate ball from outer track (by pushing it into the water). Use red button to add a ball. Wait until a ball on the inner tracks hits the ice, then press the red button. This should sync it up. Use green button on left side to change the door of the clone machine to open/close state.

Level: **122** Code: **SJUM** Title: **TOTALLY FAIR**

Interesting level, with very simple, sparse layout. Lead 1st mouth into water trap. Make sure not to kill the 2nd mouth, and not to grab the 4 chips at the mouth of the exit. Lead the 2nd mouth monster through the right part of the maze, and have it rest on the brown button. Exit out and grab 2 chips, then the remaining 4 chips.

Level: **123** Code: **YKZE** Title: **THE PRISONER**

Maneuver so that the monsters are trapped on the bottom force floors, while disabling clone machine. Exit and chip is on the right. One chip is on the left and another at the bottom. At most, 2 monsters should remain to chase you.

Level: **124** Code: **TASX** Title: **FIRETRAP**

The concept of pushing dirt blocks to divert wandering monsters into hitting trap door buttons is practiced here (similar to level 9). Direct fire ball to hit the blue button on lower right of this level. Fire shield is at the right of the tanks near the top. Once the fire shield is obtained, this level is a snap.

Level: **125** Code: **MYRT** Title: **MIXED NUTS**

A neat level. The only hard part is grabbing the first 11 chips. For the first 4 chips, you'll need to place dirt blocks into the water, making sure to trap the shark between the middle 2 dirt blocks. Starting with the extreme left (or right) chip, it's a matter of dodging the shark to get the next 3 chips. To get the next 7 chips, remember to push the blocks in the diagonal hallway either down or to the left, but always start pushing from the top of the dirt block stack. The remaining chips are easy to obtain. You must use the teleport at the upper right hand side of the level to get to the exit.

Level: **126** Code: **QLRD** Title: **ROCK N ROLL**

Very frustrating level There's a total of 36 chips to be obtained. 13 are near the start, either in the cells, or accessed by building bridges. 2 are just above a water trap. 6 are in a room protected by a bug. 1 is near the top right of the level, behind 3 dirt blocks. 1 is at the right of the level, behind 3 dirt blocks. 7 exist in the bottom right, hidden under dirt blocks (be very careful of these - some of the dirt blocks hide fire. use the chart below). The last 6 exist in a series of islands at the upper left. I started this level by grabbing the first 13 chips, then obtaining the 2 chips guarded by water. Once these two chips are obtained, the rest of the level is relatively easy, given that you can tip-toe across the x-monsters well. The chips at the upper left of this level are accessed by building bridges across islands. I started with the 2 chips at the far right, and worked my way clockwise. The last chip obtained is at the far upper left corner. You'll need to traverse the second to the last column by filling it with dirt blocks. One of the dirt blocks turned out to be pushed from somewhere far to the right. But I think, the whole key to this level is carefully tip-toeing across the x-monsters. The chart below shows the layout of the dirt blocks at the bottom right of this level. Everything that's not a fire trap is a chip.

Level 126

 Hidden fire trap

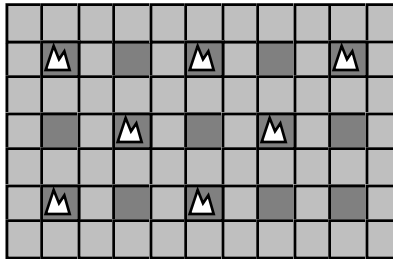

Level: **127**

Code: **JMWZ** Title: **SKELZIE**

Interesting level that requires several passes through a series of 8 rooms, in order to get all the chips. The following directions describe the direction of movement into a teleport, starting at room 1. UP-2, step up then down. RT-3, grab right chip. LT-4, grab all the chips, and watch out for the blue ball bouncing to the right. UP-5, grab all the chips. UP-6, grab the top chip. D-7. RT-8, grab the right chip. LT-1, grab left chip. RT-2. UP-3. D-4. U-5. LT-6, grab left chip. RT-7. D-8. U-1. From here cycle through the 8 rooms until all the chips are obtained along with the red key. Exit at room 8; there will be 4 chips remaining. Head for the red door (upper right), then the blue door (lower left), then the yellow door (lower right), then the green door (top left). Press the green button, head to room 1 then to the exit.

Level 127

- | | | |
|---------------|----------|-----|
| Chip | Exit | Key |
| One way floor | Wall | |
| Trap | Teleport | |

Room 1

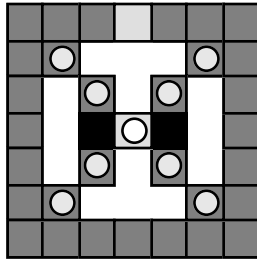

Room 5

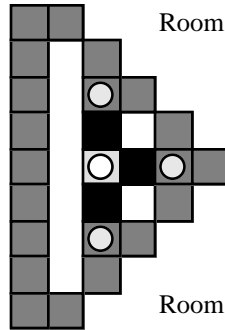

Green button

Green Door

Chip

Blue Key

Red Door

Chip

Room 2

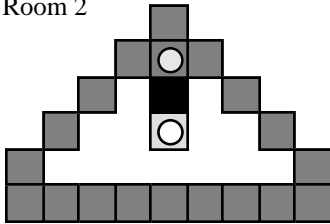

Room 6

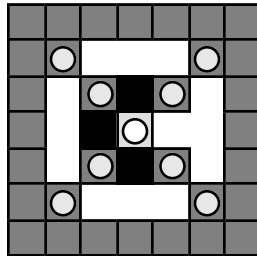

Yellow key

Blue door

Chip

Trap door

Room 1

Yellow door

Green key

Chip

Room 3

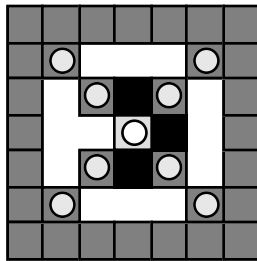

Room 7

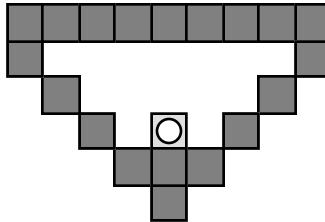

Room 4

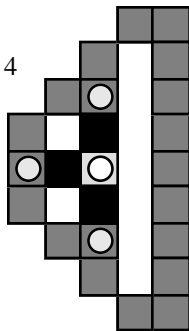

Room 8

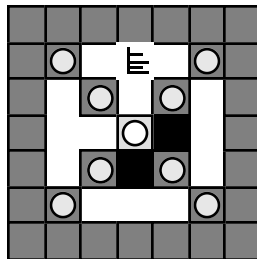

Level: **128**

Code: **FTLA**

Title: **AIR FULL**

From the start, you'll need to get the water shield. Keep pressing the red-button just below the water shield's position until all the blue balls are jammed up. Grab the yellow key to the far right of the starting position. Head down, into the yellow door, past the burglar. Wait until a fire ball comes around, and immediately follow

it. Grab the chips that you can. Head through the force floors just above the blue bouncing ball. Grab the chips that form a U. Head back down the force floor, then to the left, grabbing a yellow key. Work your way into the room where bugs are circling 4 chips; grab the chips and work your way above the ice path and keep pressing the red button until so many bugs are released that they all permanently press the red button. This disables the bug clone machine, and you can then grab the fire shield and magnet. Use these tools to obtain a total of 4 yellow keys. Then head back up, past the burglar and through the double yellow doors (the burglar doesn't steal keys). Grab all the chips. There are extra chips on this level, so don't go for a chip in which a ball or a bug is on the other side. The rest is easy.

Level: **129** Code: **HEAN** Title: **LOBSTER TRAP**

Relatively easy level. The white sharks are left-side wall huggers - when they come to a T intersection, they always branch left. They'll only turn if they hit a dirt path or a wall. Keeping this in mind, from the starting position, move straight up, and create a large loop for the sharks to get trapped in. Head back down to where the sharks are, and punch a hole so that sharks begin to move out. You'll probably have to punch one or two more holes to ensure all sharks are out. When all is clear, wait until the last bug, and follow it to the top and work your way down grabbing all 6 chips. The bugs should end up disappearing out of the room..

Level: **130** Code: **XHIZ** Title: **ICE CUBE**

Similar to level 61 (RINK). This also has no time limit, but it does have a lone wandering bug running around the perimeter of the ice. At the end of this level, the following screen appears: " 'I'VE MAD IT THIS FAR,' CHIP THINKS. 'TOTALL FAIR, WITH MY MEGA-BRAIN.' THEN HE STARTS THE NEXT MAZE. 'TOTALLY UNFAIR!' HE YELPS. "

Level 130

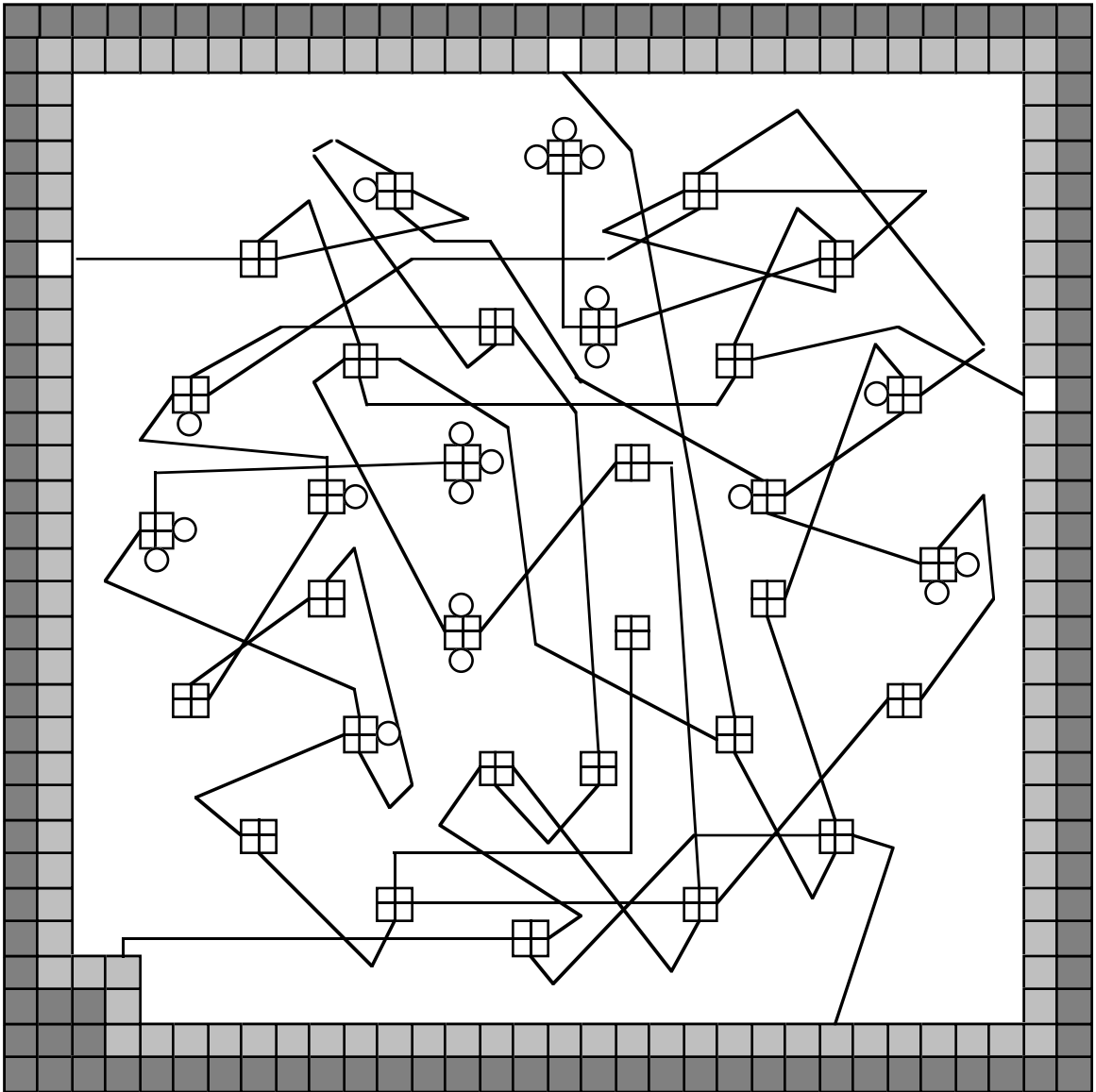

Level: **131**

Code: **FIRD**

Title: **TOTALLY UNFAIR**

The words at the end of the previous level are good advice. There's a question mark square on this level that says "REMEMBER SJUM", which refers to the code word for level 122 "TOTALLY FAIR". The same techniques used to solve that level, is used here. You must lead the bug to step onto the button. With level 122, you could go into actual maze. With this level, you can't go into the maze, so the bottom diagram shows the interior of the room you can't see. You'll need to approach the question mark, to initially lead the mouth monster to the bottom. From there, head to the right, hugging the wall. Once to the right of the room, you'll need to maneuver up and down, leading the bug into the button. Time is short (60), so speed frequent pausing may be necessary to figure out the correct point of pausing.

Level 131

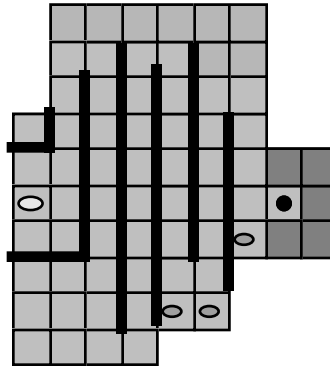

Level: **132** Code: **ZYFA** Title: **MIX UP**

A well put together level with lots of time to do your thing (999 clocks) - this is a good test of dirt block moving skills - not the coordination aspect, but the logical movement of blocks. On the far upper left of the level, there are 4 vertical-placed blocks. You'll need all these to span the water to grab the red key - push the top most block one space to the left, then push the block 3rd from the top to the left. Then push the block 2nd from the top, up. The rest is simple. Once the red key is obtained, you can go through the red door, and move the blocks around to burst all the bombs that lead to the green key. Again, all blocks are necessary. You can head back to the upper middle of the level to grab the dirt blocks that span the horizontal water barrier that leads to the mouth monster, and 23 of the 28 chips - blocks in this area have to be pushed to the left, where you can double back on them to push back to the right, and down, into position. The mouth monster trapped in the gravel/dirt is interesting. I stepped on the top left and top right dirt blocks. then waited above the remaining left-most, top block. Then with a quick movement, you can run across 2 spaces, then down, then back up again. Lead the mouth monster into this extra space to give yourself enough headstart to grab the blue key. Head down to the bottom left and use all the dirt blocks to span both the 3-block vertical span of water, and the 4-block. The 3-block leads to 4 more chips. The 4 block leads to the final chip. Use the blue key to open the blue door - grab the other blue key and lead the mouth monster out of that room, and up into the force floor, to be sucked into the ice. The last chip and exit are a piece of cake.

Level: **133** Code: **TIGG** Title: **BLOBDANCE**

Geez, what a tedious level!. You hop from room to room grabbing 2 chips per room. Each room is guarded by an increasing number of green blobs. The first few rooms start out with only 1 blob, but steadily increase, until the very last room containing the last 2 chips, which has 7 blobs. The exit is in the far left, bottom room, against the bottom wall. I went kamikaze-style until I had 16 chips left to go. Then I was more careful. Patience is extremely important in this level. So is luck.

Level: **134** Code: **XPPH** Title: **PAIN**

This is an apt title for this level, for it is a royal, tedious, PAIN in the butt to complete. You'll need to start the level by pushing a dirt block that's next to the brown button where the bugs are, and use this to cross the water. I don't know if there is a surefire way to get through the bugs. From the starting position, I ran to the right until I was above the right-most dirt floor. I waited until the single bug that was

circling over the 2 chips was touched by another bug, and bounced against the dirt floor. At this point just push the block out. Once across the water. Place a dirt block to prevent bugs from crossing. The first order of business is to get the water shield, and then to trap the 2 sharks. Use the location where the fire shield was, and an area just to the right of it to trap the 2 sharks so they continuously bounce up and down. You'll need 2 blocks for each shark. Then push dirt blocks along the right-most column down to the very last chip. From this right most wall, you'll need to build a bridge from right to left that almost comes to the left side of the level. You'll need bridges along the left-most column, and the 4th from the left column to meet with this first bridge. The exit is at the bottom right corner, and you'll need to build a bridge all the way across the bottom to reach it. Very tedious, and a PAIN.

Level: **135** Code: **LYWO** Title: **TRUST ME**

Interesting level with lots of red herrings. There are no chips to capture, just find the exit in 300 clocks. Head down from the starting position, turn right, underneath the blue tank, above the line of horizontal blue balls until you get to the ice rink. Traverse the ice rink (step down at the left edge of the rink when you get there), until you end up above where you started. Work your way through the blue walls, grab the magnet, and head back where you came from. Find that blue tank again, and walk just above it to the right, going through the one way floors. Grab the yellow key, and it's a piece of cake to the exit.

Level: **136** Code: **LUZL** Title: **DOUBLEMAZE**

Very, very, tough level that was very difficult and time-consuming to map out. As the name implies, there are two mazes embedded in this level - one with chips on even rows, and the other with chips on the odd rows. The two mazes are shown below, along with the paths to each chip. Start by doing Maze 2, then switch over to Maze 1. At the upper right corner of Maze 1, you'll need to use the corner in order to grab the 2 chips that couldn't be obtained while on the initial Maze 2 run. The exit is at the upper left corner of Maze 1. When I finally ran all the way through this level, once both maps were completed, I didn't look at the Lynx screen until the very end, for fear I'd lose my place. Of all the maze-type levels I've encountered so far, this must be the hardest and longest to complete.

Level 136

Maze 2

■ Maze 1 chip
■ Maze 2 chip

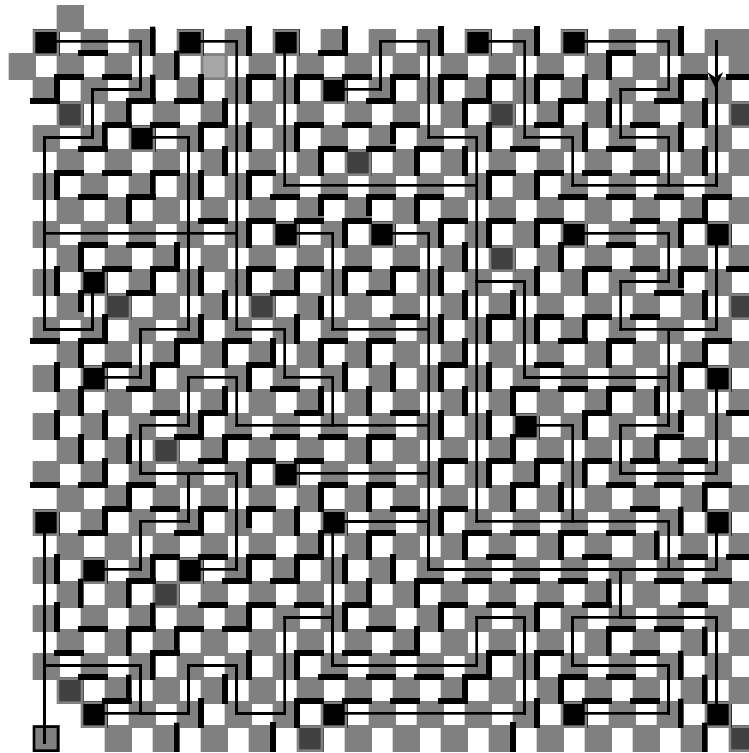

Level: **137**

Code: **HPPX** Title: **GOLDKEY**

From the starting position, move straight up until you're one row before the blue horizontal walls; turn the right right, move down one row just before getting under the first gold key, and pause there for just a moment. Then proceed to the gravel square further to the right. Next, grab the 5 keys. The first key is on the bottom. Go up, and hide in the nook to the left until the bug passes. Then go to the right, Duck into another nook until a bug passes, then collect the 3 yellow keys on the right. Stay on gravel square until the two bugs meet at the bottom, and one of them starts spinning around in circles. Go back up and get the 5th key that's next to the fire. Proceed up the 4 yellow doors, work your way around the force floors, grab another key, head towards the 2 yellow doors on the left. You should have no keys left at this point. Push the dirt block so it blocks the pink bugs. Go up and grab the single key just underneath the yellow doors and blue wall. Work your way down and to the right - grab the single key which is on the same row as the pink monsters. Work your back to the entrance at the far left of the force floors. Work your way all the way to the right, go up along the force floor, and to the left. Open the two doors. Head to the left, across the blue balls, grab the water shield, go into the bug room, grab that key, then down along the left wall to grab a 2nd yellow key. Work your way back until you get to the single yellow door - enter it, and wait until the right moment to go through a hidden entrance at the corner where the cloned bugs are coming down. You'll travel all the way to the right to the exit.

By the way, this level's code "HPPX" was shown in level 34, "CYPHER".

Level: **141** Code: **MCJE** Title: **UNDERGROUND**

Tough level which involves those right-wall-hugging pink bugs. The key to this level is to remember that these bugs, as they move forward, always hug a right wall. Use this to make all the bugs circle around a single block. The exit is at the upper right corner of the level.

Level: **142** Code: **UCRY** Title: **PENTAGRAM**

The blue question mark at this level says: " WALK THE LINES OF THIS INSCRIBED PENTAGRAM TO AVOID ITS CURSE "

I don't know if the path below is unique, but it took me a while to figure it out. Originally, the shape of the path sort of implied that you had to traverse all the blocks, but that turned out to be a mistake.

Level 142

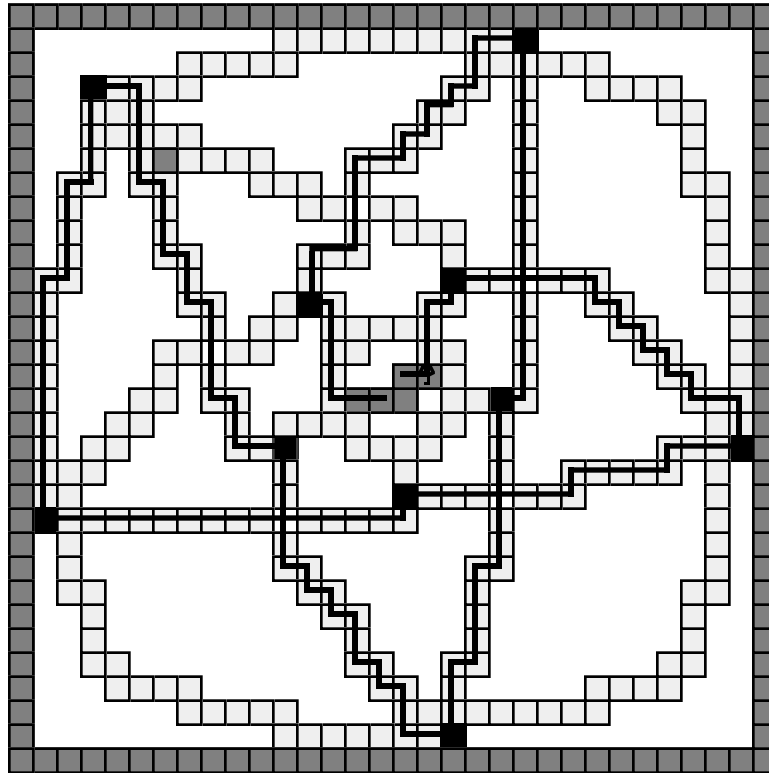

Level: **143** Code: **OKOR** Title: **STRIPES?**

Interesting maze with lots of invisible walls, and with a diagonal flair.

Level 143

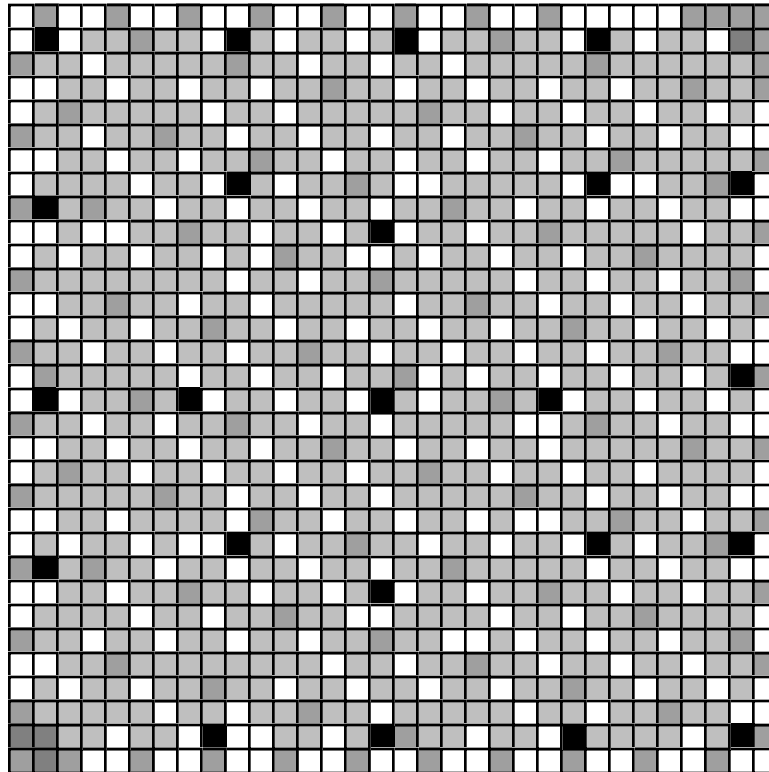
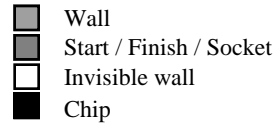

Level: **144** Code: **GVXQ** Title: **FIREFLIES**

A neat level - play dodge ball against fireballs. The gravel blocks indicates a safe area in which to stand; fireballs won't hit you here. The key to this level is patience - even if you have to traverse a 2-block area, take your time and let a fireball pass before you go for it; anyway, there's no time limit. From the start, I headed in a clockwise direction. Starting at the 3 o'clock position, work your way all the way around, until you get back to the 3 o'clock position. The exit is at the 9 o'clock position, near the center of the screen.

At the completion of this level, two screens flash alternately, with a multiple-block dissolve effect between the two. In the first screen, Chip is in front of his home computer (looks like the back of a PC, and a PC keyboard) being hugged by Melinda from behind. Our hero, Chip, has on his red shirt, and his black rimmed glasses. Melinda is blonde, and looks like she lifts weights. Chip's eyes and mouth are animated slightly (expressing happiness), and Melinda's eye's twitch a little. The second screen looks like a veranda, with three pillars in the background, 3 silhouettes of dancing couples, and in the foreground, there is a green banner hung between the pillars, with the yellow word "E-PROM" written on it. I guess they live happily ever after.

Hidden Levels

Level: **UNKNOWN** Code: **MAND** Title: **MANDELBROT**

This is a "hidden" level in Chip' Challenge which is a Mandelbrot (and Julia Set) fractal graphics generator. Neat stuff. The controls are listed below

THUMB PAD	Movement of zoom/dezoom window
A	Zoom in
B	Zoom out
OPTION 1	Stop/start generation
PAUSE	Parameter menu. In this menu OPTION 2 chooses between Mandelbrot and Julia Set Explorer. Pressing OPTION 1 restarts the generation.
OPTION 2	During calculations this will toggle between three modes: Pressing 1 : Stops generation. Pressing 2 : Performs animation by color cycling Pressing 3 : Reverses cycle direction.

Level: **146** Code: **JHEN** Title: **CAKE WALK**

The code for this level was hidden in the background in Level 34 "CYPHER". This is an interesting level, but a little tedious. From the starting location, push the dirt block on the right all the way up until it blocks the fire ball clone machine. Then use the blocks on the right side of this level to form a bridge starting at the 2-block wide opening near the center hallway, and spans down and across to the left. Pick up 4 chips here, along with a red key. Then use some dirt blocks to span across back to the middle ice bridge so that you can push a dirt block from the bottom until it lodges the blue ball that's bouncing horizontally, against a wall. Go straight up and grab the yellow key. Now head to the left part of this level, and use the dirt blocks at this side, along with a few from the right to make a bridge that uses the ice wall to shoot dirt blocks down and to the left. Collect the 4 chips and the key, along with the 5 chips on the right. Head down the center hallway, grab the magnet first, then the fire shield. Use one of the two dirt blocks near the entrance of the fire room to cross the water and grab the red key. Then walk across the force floor and open the red door which the 2nd dirt block will land. Go back and push the dirt block into the open door. Wait until a shark passes, and quickly push the block into the water, and across to the exit.

Level: **147** Code: **COZA** Title: **FORCE FIELD**

Super-tough, devious, level. Even with the map below, you'll need to grow adept at using the pause button frequently to figure out where you are and where you're going. You'll need to grab all 24 chips before going to the socket and magnet at the center of the level.

Level 147

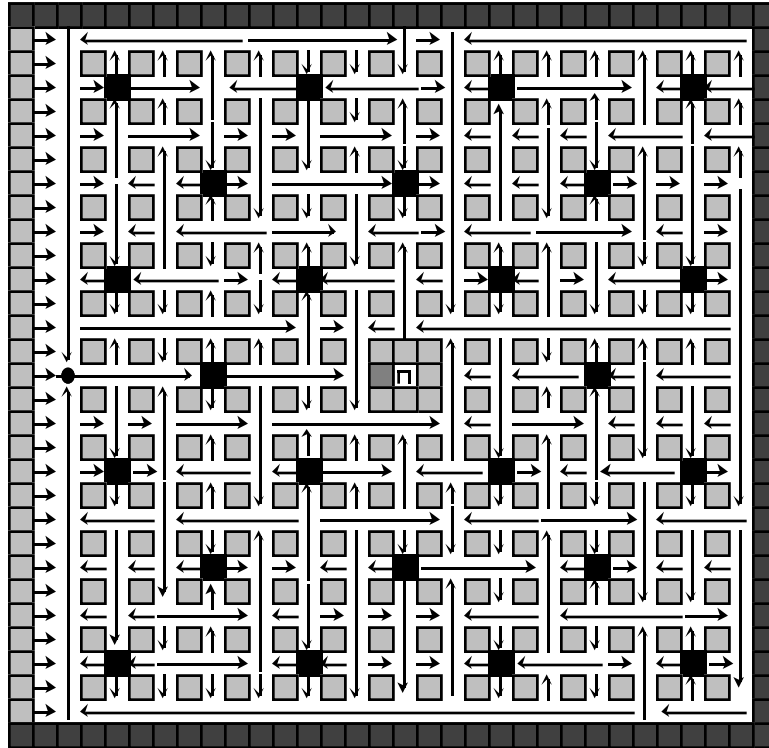

Level: **148** Code: **RGSK** Title: **MIND BLOCK**

Very tedious level that is actually quite simple. Almost the entire level is filled with bombs, with a dirt block generator near the red button that activates it. I went from the room at the bottom, and worked my way clockwise to get all 12 chips. The exit is at the top room, on the right. Good joystick control is a must - don't rush through this - it's easy to take an extra step, and right into a bomb.

Level: **149** Code: **DIGW** Title: **SPECIAL**

It helps in this level to know how to push a dirt block without actually stepping into the space it leaves free. Do this by moving past it in a diagonal motion, brushing it as you go by. This level is basically a hide-and-seek level, trying to find which block the exit is in. Once you exit, you end up going to the same 2 end screens that finished level 144.

Level 149

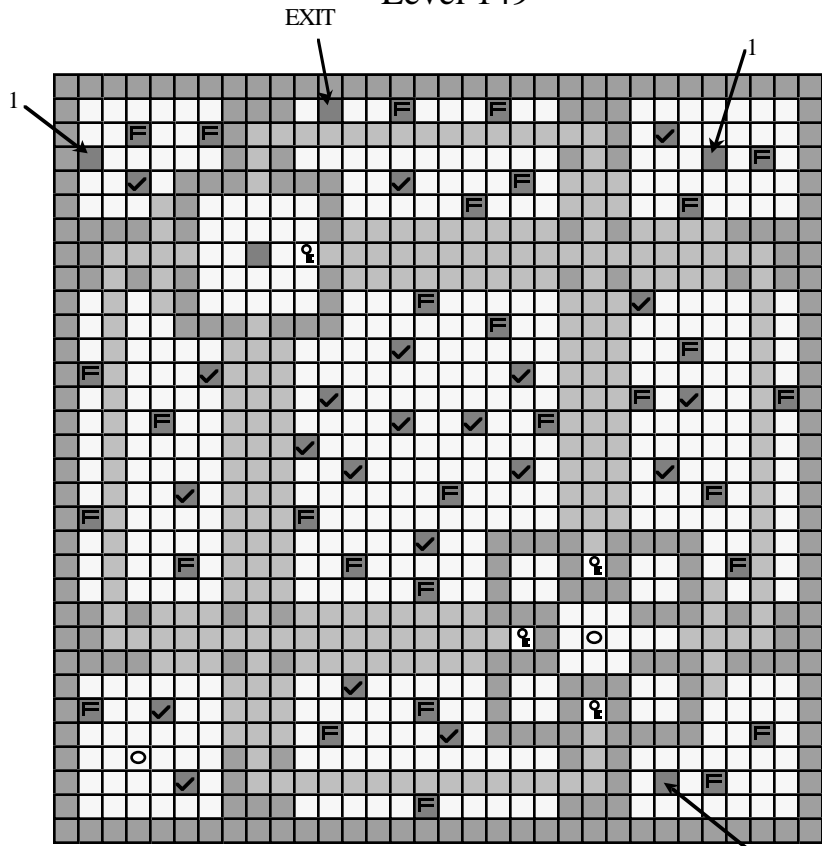

- | | | | |
|---|-------|---|---------------------------|
| ■ | Wall | ■ | Dirt block |
| □ | Floor | ✓ | Confirmed dirt block |
| ■ | Ice | F | Dirt block with fire trap |
| ■ | Water | | |
- 1 -The ? underneath says:
"THIS SPOT WOULD BE
TOO OBVIOUS!"

Appendix A - Levels sorted by Level Name

Title:	AIR FULL	Level:	128	Code:	FTLA
Title:	ALLEY	Level:	72	Code:	EKFT
Title:	ALPHABET SOUP	Level:	120	Code:	FLXP
Title:	AMSTERDAM	Level:	65	Code:	UPUN
Title:	APARTMENT	Level:	101	Code:	RPIR
Title:	ARTIC FLOW	Level:	29	Code:	QGOL
Title:	BALLS O FIRE	Level:	107	Code:	ECRE
Title:	BEWARE OF BUG	Level:	42	Code:	LMFU
Title:	BLINK	Level:	25	Code:	PQGV
Title:	BLOBDANCE	Level:	133	Code:	TIGG
Title:	BLOBNET	Level:	23	Code:	HUVE
Title:	BLOCK BUSTER	Level:	89	Code:	VCZO
Title:	BLOCK BUSTER II	Level:	116	Code:	HXMF
Title:	BLOCK OUT	Level:	108	Code:	LIOC
Title:	BOUNCE CITY	Level:	69	Code:	NLLY
Title:	BRUSHFIRE	Level:	10	Code:	UVWS
Title:	CAKE WALK	Level:	146	Code:	JHEN
Title:	CASTLE MOAT	Level:	18	Code:	HMJL
Title:	CATACOMBS	Level:	99	Code:	XUVU
Title:	CELLBLOCK	Level:	16	Code:	SKKK
Title:	CHCHCHIPS	Level:	26	Code:	YVYJ
Title:	CHILLER	Level:	110	Code:	XBAO
Title:	CHIPMINE	Level:	67	Code:	GGJA
Title:	CITYBLOCK	Level:	87	Code:	YJYS
Title:	COLONY	Level:	100	Code:	QJXR
Title:	CORRIDOR	Level:	71	Code:	LAJM
Title:	CYPHER	Level:	34	Code:	NQFI
Title:	DECEPTION	Level:	114	Code:	JWNL
Title:	DEEPFREEZE	Level:	56	Code:	FCJE
Title:	DIGDIRT	Level:	50	Code:	QBDH
Title:	DIGGER	Level:	19	Code:	MRHR
Title:	DOUBLEMAZE	Level:	135	Code:	LUZL
Title:	DRAWN AND QUARTERED	Level:	79	Code:	JINU
Title:	EENY MINY MOE	Level:	68	Code:	RTDI
Title:	ELEMENTARY	Level:	15	Code:	COZQ
Title:	FACTORY	Level:	63	Code:	GOHX
Title:	FIREFLIES	Level:	144	Code:	GVXQ
Title:	FIRETRAP	Level:	124	Code:	TASX
Title:	FLOORGASBORG	Level:	40	Code:	YWFH
Title:	FORCE	Level:	78	Code:	GRMO
Title:	FORCE FIELD	Level:	147	Code:	COZA
Title:	FORCED ENTRY	Level:	22	Code:	WZIN
Title:	FORTUNE FAVORS THE	Level:	112	Code:	NJLA
Title:	FOUR CORNERS	Level:	95	Code:	BIFQ
Title:	FOUR PLEX	Level:	76	Code:	NMRH
Title:	GLUT	Level:	39	Code:	ICXY
Title:	GO WITH THE FLOW	Level:	27	Code:	IGGZ
Title:	GOLDKEY	Level:	137	Code:	HPPX
Title:	GRAIL	Level:	54	Code:	ZMGC
Title:	HIDDEN DANGER	Level:	59	Code:	BLDM
Title:	HUNT	Level:	12	Code:	WVHI
Title:	I SLIDE	Level:	51	Code:	IGGJ
Title:	I.C. YOU	Level:	41	Code:	GKWD
Title:	ICE CUBE	Level:	130	Code:	XHIZ
Title:	ICEBERG	Level:	21	Code:	UGRW

Title: ICEDEATH	Level: 140	Code: SJUK
Title: ICEHOUSE	Level: 102	Code: VDDU
Title: INVICIBLE CHAMPION	Level: 77	Code: FHIC
Title: JAILER	Level: 104	Code: KWNL
Title: JUMPING SWARM	Level: 91	Code: JPQG
Title: KABLAM	Level: 106	Code: NXYB
Title: KNOT	Level: 31	Code: RYMS
Title: LADDER	Level: 36	Code: NXIS
Title: LEMMINGS	Level: 35	Code: VDTM
Title: LESSON 1	Level: 1	Code: BDHP
Title: LESSON 2	Level: 2	Code: JXMJ
Title: LESSON 3	Level: 3	Code: ECBQ
Title: LESSON 4	Level: 4	Code: YMCJ
Title: LESSON 5	Level: 5	Code: TQKB
Title: LESSON 6	Level: 6	Code: WNLD
Title: LESSON 7	Level: 7	Code: FXQO
Title: LESSON 8	Level: 8	Code: NHAG
Title: LOBSTER TRAP	Level: 129	Code: HEAN
Title: LOCK BLOCK	Level: 43	Code: UJDP
Title: LOOPING AROUND	Level: 58	Code: YBLT
Title: MANDELBRÖT	Level: UNKNOWN	Code: MAND
Title: MEMORY	Level: 103	Code: PTAC
Title: METASTABLE TO CHAOS	Level: 97	Code: IOCS
Title: MIND BLOCK	Level: 148	Code: RGSK
Title: MISH MESH	Level: 30	Code: BQZP
Title: MISS DIRECTION	Level: 118	Code: OSCW
Title: MIX UP	Level: 132	Code: ZYFA
Title: MIXED NUTS	Level: 125	Code: MYRT
Title: MONSTER LAB	Level: 45	Code: OVPZ
Title: MORTON	Level: 73	Code: QCCR
Title: MUGGER SQUARE	Level: 48	Code: JYSF
Title: NICE DAY	Level: 17	Code: AJMG
Title: NIGHTMARE	Level: 70	Code: GCCG
Title: NOW YOU SEE IT	Level: 94	Code: EWCS
Title: NUTS AND BOLTS	Level: 9	Code: KCRE
Title: ON THE ROCKS	Level: 33	Code: BQSN
Title: OORTO GELD	Level: 24	Code: UNIZ
Title: OPEN QUESTION	Level: 113	Code: PTAS
Title: OVERSEA DELIVERY	Level: 115	Code: EGRW
Title: PAIN	Level: 134	Code: XPPH
Title: PARANOIA	Level: 96	Code: WWHY
Title: PARTIAL POST	Level: 138	Code: LUJT
Title: PENTAGRAM	Level: 142	Code: UCRY
Title: PERFECT MATCH	Level: 121	Code: BPYS
Title: PIER SEVEN	Level: 47	Code: LXPP
Title: PING PONG	Level: 28	Code: UJDO
Title: PLAY HOUSE	Level: 90	Code: OLLM
Title: PLAYTIME	Level: 74	Code: MKNH
Title: POTPOURRI	Level: 55	Code: SJES
Title: PROBLEMS	Level: 49	Code: PPXI
Title: REFRACTION	Level: 44	Code: TXHL
Title: RINK	Level: 61	Code: RMOW
Title: ROADSIGN	Level: 93	Code: REKF
Title: ROCK N ROLL	Level: 126	Code: QRLD
Title: SAMPLER	Level: 38	Code: BIFA
Title: SCAVENGER HUNT	Level: 32	Code: PEFS
Title: SCOUNDREL	Level: 60	Code: ZYVI
Title: SEEING STARS	Level: 37	Code: VQNK

Title: SHORT CIRCUIT	Level: 105	Code: YNEG
Title: SHRINKING	Level: 98	Code: TKWD
Title: SKELZIE	Level: 127	Code: JMWZ
Title: SLIDE STEP	Level: 119	Code: PHTY
Title: SLO MO	Level: 62	Code: TIGW
Title: SOCIALIST ACTION	Level: 82	Code: LLIO
Title: SOUTHPOLE	Level: 13	Code: OCKS
Title: SPECIAL	Level: 149	Code: DIGW
Title: SPIRALS	Level: 88	Code: WZYY
Title: SPOOKS	Level: 64	Code: IJPQ
Title: STEAM	Level: 75	Code: MJDV
Title: STRANGE MAZE	Level: 57	Code: UBXU
Title: STRIPES?	Level: 143	Code: OKOR
Title: SUICIDE	Level: 86	Code: FLHH
Title: TELEBLOCK	Level: 14	Code: BTDY
Title: TELENET	Level: 85	Code: LEBX
Title: THE LAST LAUGH	Level: 52	Code: PPHT
Title: THE MARSH	Level: 117	Code: FPZT
Title: THE PRISONER	Level: 123	Code: YKZE
Title: THREE DOORS	Level: 46	Code: HDQJ
Title: TIME LAPSE	Level: 111	Code: KRQJ
Title: TORTURE CHAMBER	Level: 109	Code: KZQR
Title: TOSSED SALAD	Level: 20	Code: KGFP
Title: TOTALLY FAIR	Level: 122	Code: SJUM
Title: TOTALLY UNFAIR	Level: 131	Code: FIRD
Title: TRAFFIC COP	Level: 53	Code: CGNX
Title: TRINITY	Level: 11	Code: CNPE
Title: TRUST ME	Level: 135	Code: LYWO
Title: UNDERGROUND	Level: 141	Code: MCJE
Title: UP THE BLOCK	Level: 83	Code: OVPJ
Title: VANISHING ACT	Level: 80	Code: EVUG
Title: VICTIM	Level: 66	Code: ZIKZ
Title: VORTEX	Level: 92	Code: DTMI
Title: WARS	Level: 84	Code: UVEO
Title: WRITERS BLOCK	Level: 81	Code: SCWF
Title: YORKHOUSE	Level: 139	Code: VLHH

Appendix B - Levels sorted by Level Code

Code: AJMG	Level: 17	Title: NICE DAY
Code: BDHP	Level: 1	Title: LESSON 1
Code: BIFA	Level: 38	Title: SAMPLER
Code: BIFQ	Level: 95	Title: FOUR CORNERS
Code: BLDM	Level: 59	Title: HIDDEN DANGER
Code: BPYS	Level: 121	Title: PERFECT MATCH
Code: BQSN	Level: 33	Title: ON THE ROCKS
Code: BQZP	Level: 30	Title: MISH MESH
Code: BTDY	Level: 14	Title: TELEBLOCK
Code: CGNX	Level: 53	Title: TRAFFIC COP
Code: CNPE	Level: 11	Title: TRINITY
Code: COZA	Level: 147	Title: FORCE FIELD
Code: COZQ	Level: 15	Title: ELEMENTARY
Code: DIGW	Level: 149	Title: SPECIAL
Code: DTMI	Level: 92	Title: VORTEX
Code: ECBQ	Level: 3	Title: LESSON 3
Code: ECRE	Level: 107	Title: BALLS O FIRE
Code: EGRW	Level: 115	Title: OVERSEA DELIVERY
Code: EKFT	Level: 72	Title: ALLEY
Code: EVUG	Level: 80	Title: VANISHING ACT
Code: EWCS	Level: 94	Title: NOW YOU SEE IT
Code: FCJE	Level: 56	Title: DEEPFREEZE
Code: FHIC	Level: 77	Title: INVICIBLE CHAMPION
Code: FIRD	Level: 131	Title: TOTALLY UNFAIR
Code: FLHH	Level: 86	Title: SUICIDE
Code: FLXP	Level: 120	Title: ALPHABET SOUP
Code: FPZT	Level: 117	Title: THE MARSH
Code: FTLA	Level: 128	Title: AIR FULL
Code: FXQO	Level: 7	Title: LESSON 7
Code: GCCG	Level: 70	Title: NIGHTMARE
Code: GGJA	Level: 67	Title: CHIPMINE
Code: GKWD	Level: 41	Title: I.C. YOU
Code: GOHX	Level: 63	Title: FACTORY
Code: GRMO	Level: 78	Title: FORCE
Code: GVXQ	Level: 144	Title: FIREFLIES
Code: HDQJ	Level: 46	Title: THREE DOORS
Code: HEAN	Level: 129	Title: LOBSTER TRAP
Code: HMJL	Level: 18	Title: CASTLE MOAT
Code: HPPX	Level: 137	Title: GOLDKEY
Code: HUVE	Level: 23	Title: BLOBNET
Code: HXMF	Level: 116	Title: BLOCK BUSTER II
Code: ICXY	Level: 39	Title: GLUT
Code: IGGJ	Level: 51	Title: I SLIDE
Code: IGGZ	Level: 27	Title: GO WITH THE FLOW
Code: IJPQ	Level: 64	Title: SPOOKS
Code: IOCS	Level: 97	Title: METASTABLE TO CHAOS
Code: JHEN	Level: 146	Title: CAKE WALK
Code: JINU	Level: 79	Title: DRAWN AND QUARTERED
Code: JMWZ	Level: 127	Title: SKELZIE
Code: JPQG	Level: 91	Title: JUMPING SWARM
Code: JWNL	Level: 114	Title: DECEPTION
Code: JXMJ	Level: 2	Title: LESSON 2
Code: JYSF	Level: 48	Title: MUGGER SQUARE
Code: KCRE	Level: 9	Title: NUTS AND BOLTS
Code: KGFP	Level: 20	Title: TOSSED SALAD

Code: KRQJ	Level: 111	Title: TIME LAPSE
Code: KWNL	Level: 104	Title: JAILER
Code: KZQR	Level: 109	Title: TORTURE CHAMBER
Code: LAJM	Level: 71	Title: CORRIDOR
Code: LEBX	Level: 85	Title: TELENET
Code: LIOC	Level: 108	Title: BLOCK OUT
Code: LLIO	Level: 82	Title: SOCIALIST ACTION
Code: LMFU	Level: 42	Title: BEWARE OF BUG
Code: LUJT	Level: 138	Title: PARTIAL POST
Code: LUZL	Level: 135	Title: DOUBLEMAZE
Code: LXPP	Level: 47	Title: PIER SEVEN
Code: LYWO	Level: 135	Title: TRUST ME
Code: MAND	Level: UNKNOWN	Title: MANDELBROT
Code: MCJE	Level: 141	Title: UNDERGROUND
Code: MJDV	Level: 75	Title: STEAM
Code: MKNH	Level: 74	Title: PLAYTIME
Code: MRHR	Level: 19	Title: DIGGER
Code: MYRT	Level: 125	Title: MIXED NUTS
Code: NHAG	Level: 8	Title: LESSON 8
Code: NJLA	Level: 112	Title: FORTUNE FAVORS THE
Code: NLLY	Level: 69	Title: BOUNCE CITY
Code: NMRH	Level: 76	Title: FOUR PLEX
Code: NQFI	Level: 34	Title: CYPHER
Code: NXIS	Level: 36	Title: LADDER
Code: NXYB	Level: 106	Title: KABLAM
Code: OCKS	Level: 13	Title: SOUTHPOLE
Code: OKOR	Level: 143	Title: STRIPES?
Code: OLLM	Level: 90	Title: PLAY HOUSE
Code: OSCW	Level: 118	Title: MISS DIRECTION
Code: OVPJ	Level: 83	Title: UP THE BLOCK
Code: OVPZ	Level: 45	Title: MONSTER LAB
Code: PEFS	Level: 32	Title: SCAVENGER HUNT
Code: PHTY	Level: 119	Title: SLIDE STEP
Code: PPHT	Level: 52	Title: THE LAST LAUGH
Code: PPXI	Level: 49	Title: PROBLEMS
Code: PQGV	Level: 25	Title: BLINK
Code: PTAC	Level: 103	Title: MEMORY
Code: PTAS	Level: 113	Title: OPEN QUESTION
Code: QBDH	Level: 50	Title: DIGDIRT
Code: QCCR	Level: 73	Title: MORTON
Code: QGOL	Level: 29	Title: ARTIC FLOW
Code: QJXR	Level: 100	Title: COLONY
Code: QRLD	Level: 126	Title: ROCK N ROLL
Code: REKF	Level: 93	Title: ROADSIGN
Code: RGSK	Level: 148	Title: MIND BLOCK
Code: RMOW	Level: 61	Title: RINK
Code: RPIR	Level: 101	Title: APARTMENT
Code: RTDI	Level: 68	Title: EENY MINY MOE
Code: RYMS	Level: 31	Title: KNOT
Code: SCWF	Level: 81	Title: WRITERS BLOCK
Code: SJES	Level: 55	Title: POTPOURRI
Code: SJUK	Level: 140	Title: ICEDEATH
Code: SJUM	Level: 122	Title: TOTALLY FAIR
Code: SKKK	Level: 16	Title: CELLBLOCK
Code: TASX	Level: 124	Title: FIRETRAP
Code: TIGG	Level: 133	Title: BLOBDANCE
Code: TIGW	Level: 62	Title: SLO MO
Code: TKWD	Level: 98	Title: SHRINKING

Code: TQKB	Level: 5	Title: LESSON 5
Code: TXHL	Level: 44	Title: REFRACTION
Code: UBXU	Level: 57	Title: STRANGE MAZE
Code: UCRY	Level: 142	Title: PENTAGRAM
Code: UGRW	Level: 21	Title: ICEBERG
Code: UJDO	Level: 28	Title: PING PONG
Code: UJDP	Level: 43	Title: LOCK BLOCK
Code: UNIZ	Level: 24	Title: OORTO GELD
Code: UPUN	Level: 65	Title: AMSTERDAM
Code: UVEO	Level: 84	Title: WARS
Code: UVWS	Level: 10	Title: BRUSHFIRE
Code: VCZO	Level: 89	Title: BLOCK BUSTER
Code: VDDU	Level: 102	Title: ICEHOUSE
Code: VDTM	Level: 35	Title: LEMMINGS
Code: VLHH	Level: 139	Title: YORKHOUSE
Code: VQNK	Level: 37	Title: SEEING STARS
Code: WNLD	Level: 6	Title: LESSON 6
Code: WVHI	Level: 12	Title: HUNT
Code: WVHY	Level: 96	Title: PARANOIA
Code: WZIN	Level: 22	Title: FORCED ENTRY
Code: WZYY	Level: 88	Title: SPIRALS
Code: XBAO	Level: 110	Title: CHILLER
Code: XHIZ	Level: 130	Title: ICE CUBE
Code: XPPH	Level: 134	Title: PAIN
Code: XUVU	Level: 99	Title: CATACOMBS
Code: YBLT	Level: 58	Title: LOOPING AROUND
Code: YJYS	Level: 87	Title: CITYBLOCK
Code: YKZE	Level: 123	Title: THE PRISONER
Code: YMCJ	Level: 4	Title: LESSON 4
Code: YNEG	Level: 105	Title: SHORT CIRCUIT
Code: YVYJ	Level: 26	Title: CHCHCHIPS
Code: YWFH	Level: 40	Title: FLOORGASBORG
Code: ZIKZ	Level: 66	Title: VICTIM
Code: ZMGC	Level: 54	Title: GRAIL
Code: ZYFA	Level: 132	Title: MIX UP
Code: ZYVI	Level: 60	Title: SCOUNDREL

Appendix C - Revision History

Revision	Date	Comments
1.0	05/01/90	Initial release.
1.01	07/24/90	Corrected code for level 96, Title for level 125. Added Appendix C. Modified footnotes.